

OXFORD
UNIVERSITY PRESS

OXFORD IMPACT
EVALUATED

NEW

COUNTDOWN

BOOK 5

TEACHING GUIDE

THIRD EDITION

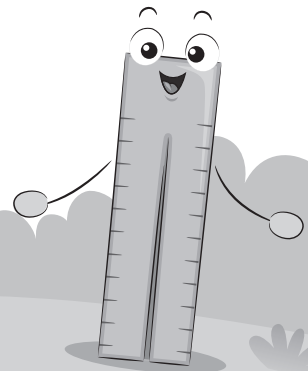
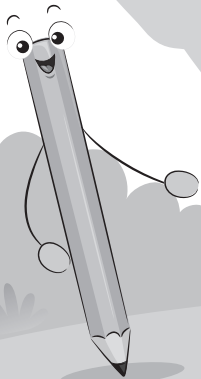
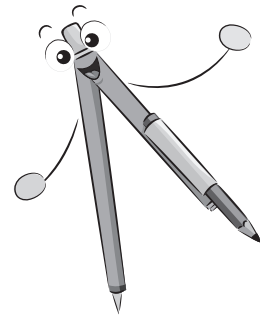
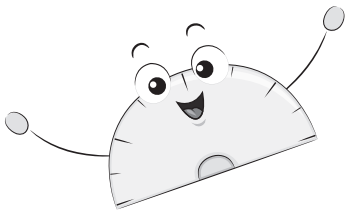

The Oxford Impact Framework is a systematic approach to evaluating the impact of Oxford University Press products and services. It was developed through a unique collaboration with the National Foundation for Educational Research (NFER) and is supported by the Oxford University Department of Education.



OXFORD IMPACT FRAMEWORK

EVALUATING EDUCATIONAL PRODUCTS AND SERVICES FROM OXFORD UNIVERSITY PRESS

CREATED WITH



**Evidence for
Excellence in
Education**

SUPPORTED BY



Department of Education
University of Oxford

Contents

Introduction	iv
Curriculum	2
• Strands and Benchmarks	
• Syllabus Matching Grid	
Teaching Mathematics at Primary Level	9
• Teaching the strands	
• Developing Positive Attitude towards Mathematics	
Features of the Teaching Guide	15
Unit overview and Lesson Planing	18
• Suggested Activities	
• Model Lesson Plan	
Assessment	66
• Specimen Paper	



Introduction

New Countdown 5 is the last of an eight-book journey into maths designed for the young mathematician of today's fast-evolving world. It includes concepts introduced earlier to a more advanced plane and presents some exciting new ideas: rounding off; simplification with and without brackets; the line graph; volume; multiplication and division with common fractions and decimal fractions; percentages and their everyday application; averages; the relationship between distance, speed, and time; and measurement of temperature. Students are introduced to more advanced geometry assignments, learning to use instruments to draw angles and construct triangles, squares, and rectangles of given dimensions and to draw perpendicular and parallel lines.

New Countdown 5 covers all the topics recommended for Class 5 learners by all major syllabuses. It also reaches beyond them in a careful, systematic way. As before, worked examples are provided for every new concept or technique. Plenty of practice exercises reinforce learning, and a range of puzzles and activities seek to guarantee the interest and involvement of every student, and help them to grow laterally. Practice sheets and Maths Lab Activities are included at the end.

New Countdown 5 comprises five major strands, each containing work which can be covered comfortably in the time available. It is recommended that you follow them in the sequence, since later portions of the book relate directly to work done or concepts introduced at an earlier stage. Problem solving is one of the most important skills to be taught at all levels. In general, it involves the ability to solve real-life problems and apply mathematics in real-life situations. Questions that enhance logical thinking skills and problem solving skills are included in all units.

But no textbook—however comprehensive—can do full justice to a subject as exciting and varied as mathematics. There is so much that you, as a creative and imaginative teacher, can do to enrich the content of this book. Some teaching ideas and activities have been suggested that you might like to incorporate in your classes.

General Note

Starting from Book 3, the workbook style followed in junior books is changed to a textbook style. Thus, it is essential that each student has a notebook to write in, as he/ she works through the book. Greater use of the board will be necessary to demonstrate new ideas. Tick-marks, stars, and smileys give students confidence that they are getting their work right and hence encourage swift progress.

The most important feature of the curriculum is its continued focus on the content of the Mathematics standards. A syllabus matching grid has been added in the Guide to facilitate the teacher to connect the students learning objectives with the text in the book. The goal of accelerating the progress of students, through a standard-based program. These standards necessitate the provision of more continued, more substantive, more rigorous and more systematic instructions to students.

Planning your work and then implementing your plan are the building blocks of teaching. Therefore, this teaching guide provides detailed lesson plan, including learning objectives, learning curves, learning activities, and guidance to implement textbook exercises.

Different activities are suggested in each unit. Teachers have the liberty to use any of these suggested activities or any other activity of their choice depending on interest of their students and time.

Use of resources are important, to make the lesson interesting, engaging and easy to understand. Teachers can prepare their own material or use any teaching or learning resource easily available, as and when required.

Shamlu Dudeja



Strands
of the
National
Curriculum
for
Mathematics

NUMBERS and OPERATIONS

MEASUREMENTS

GEOMETRY

HANDLING DATA

**REASONING and
LOGICAL THINKING**

Strands and Benchmarks of the Pakistan National Curriculum (2006)

Strand 1: Numbers and Operations

Benchmarks

- Count, read, and write numbers up to 999.
- Write numbers up to 100 in words and write ordinal numbers up to 20.
- Identify the place value of each digit in a 3-digit number.
- Add and subtract up to 3-digit numbers.
- Multiply numbers within multiplication tables of 2, 3, 4, 5, and 10.
- Divide numbers within multiplication tables of 2, 3, 4, 5, and 10 with remainder zero.
- Recognise and represent unit fractions up to 12.
- Read and write Roman numbers up to 20.
- Read, write, compare, and identify place values of numbers up to 1 000 000 000.
- Add and subtract numbers of complexity and of arbitrary size.
- Multiply and divide up to 6-digit numbers by 2-digit and 3-digit numbers.
- Distinguish between even and odd, prime and composite numbers.
- Differentiate between factors and multiples.
- Calculate HCF and LCM of 4, 3, and 2-digit numbers using prime factorisation and division method.
- Use four basic operations on fractions.
- Convert percentage to fraction and to decimal and vice versa.
- Calculate unit rate, direct, and inverse proportions.
- Add and subtract measures of distance, time, and temperature.

Strand 2: Measurement

Benchmarks

- Identify and apply measurable attributes of length, weight/ mass, capacity/ volume and time.
- Identify square, rectangle, triangle, circle, and oval.
- Add, subtract and convert standard units of length, weight/ mass, capacity/ volume, time and temperature.
- Draw, label and classify lines, angles, quadrilaterals and triangles based on their properties.
- Determine the perimeter and area of a square, rectangle, and triangle using formulas.



Strand 3: Geometry

Benchmarks

- Analyse patterns and relationships with respect to size, number, colour, shape and other properties.
- Explain and analyse patterns, identify missing numerals and elements in a pattern or sequence and determine a rule for repeating and extending patterns.
- Use symbolic notation to represent a statement of equality.

Strand 4: Handling Data

Benchmarks

Compare data and interpret quantities represented on charts, tables, and different types of graphs (pictogram and bar) and make predictions based on the information.

Strand 5: Reasoning and Logical Thinking

Benchmarks

- Sort, classify, and compare familiar shapes.
- Apply analytical reasoning to explain features of a shape.
- Communicate reasoning about patterns and geometric figures.
- Explain method and reasoning when solving problems involving numbers and data.

Syllabus Matching Grid

Left column of the following grid indicates National Curriculum SLO's, whereas the right column indicates the textbook units.

Unit 1: Numbers and Arithmetic Operations	Textbook Reference
<p>1.1 Numbers up to one billion i) Read numbers up to 1 000 000 000 (one billion) in numerals and in words. ii) Write numbers up to 1 000 000 000 (one billion) in numerals and in words.</p>	Unit 1
<p>1.2 Addition and Subtraction i) Add numbers of complexity and of arbitrary size. ii) Subtract numbers of complexity and of arbitrary size.</p>	
<p>1.3 Multiplication and Division i) Multiply numbers, up to 6 digits, by 10, 100, and 1000. ii) Multiply numbers, up to 6 digits, by a 2-digit and 3-digit number. iii) Divide numbers, up to 6 digits, by a 2-digit and 3-digit number.</p>	
<p>1.4 Order of Operations i) Apply BODMAS rule, using only parentheses (). ii) Verify distributive laws. iii) Carryout combined operations using BODMAS rule.</p>	
<p>Unit 2: HCF and LCM</p>	
<p>2.1 Highest Common Factor Find HCF of three numbers, up to 2 digits, using • prime factorisation method, • division method.</p>	Unit 2
<p>2.2 Lowest Common Multiple Find LCM of four numbers, up to 2 digits, using • prime factorisation method, • division method.</p>	
<p>2.3 Solve real-life problems involving HCF and LCM</p>	
<p>Unit 3: Fractions</p>	Unit 3
<p>3.1 Addition and Subtraction Add and subtract two and more fractions with different denominators.</p>	



<p>3.2 Multiplication</p> <ul style="list-style-type: none"> i) Multiply a fraction by a number and demonstrate with the help of diagrams. ii) Multiply a fraction by another fraction. iii) Multiply two or more fractions involving brackets. iv) Verify distributive laws. v) Solve real-life problems involving multiplication of fractions. 	Unit 3
<p>3.3 Division</p> <ul style="list-style-type: none"> i) Divide a fraction by a number. ii) Divide a fraction by another fraction. iii) Solve real-life problems involving division of fractions. 	
<p>3.4 Use of BODMAS rule</p> <ul style="list-style-type: none"> i) Simplify expressions involving fractions using BODMAS rule. 	
Unit 4: Decimals and Percentages	
<p>4.1 Decimals</p> <ul style="list-style-type: none"> i) Add and subtract decimals. ii) Recognise like and unlike decimals. iii) Multiply decimals by 10, 100, and 1000. iv) Divide decimals by 10, 100, and 1000. v) Multiply a decimal with a whole number. vi) Divide a decimal with a whole number. vii) Multiply a decimal by tenths and hundredths only. viii) Multiply a decimal by a decimal with three decimal places. ix) Multiply a decimal by a decimal. x) Divide a decimal by a decimal by converting decimals to fractions. xi) Divide a decimal by a decimal using direct division by moving decimal positions. xii) Use division to change fractions into decimals. xiii) Simplify decimal expressions involving brackets (applying one or more basic operations). xiv) Round off decimals up to a specified number of decimal places. xv) Convert fractions to decimals and vice versa. xvi) Solve real-life problems involving decimals. 	Unit 4
<p>4.2 Percentages</p> <ul style="list-style-type: none"> i) Recognise percentage as a special kind of fraction. ii) Convert percentage to fraction and to decimal and vice versa. iii) Solve real-life problems involving percentages. 	

Unit 5: Distance, Time, and Temperature	
<p>5.1 Distance</p> <p>i) Convert measures given in</p> <ul style="list-style-type: none"> • kilometres to metres, • metres to centimetres, • centimetres to millimetres and vice versa. <p>ii) Add and subtract measures of distance.</p> <p>iii) Solve real-life problems involving conversion, addition, and subtraction of units of distance.</p>	Unit 5
<p>5.2 Time</p> <p>i) Convert hours to minutes, minutes to seconds and vice versa.</p> <p>ii) Add and subtract units of time with carrying/ borrowing.</p> <p>iii) Convert years to months, months to days, weeks to days and vice versa.</p> <p>iv) Solve real-life problems involving conversion, addition, and subtraction of units of time.</p>	
<p>5.3 Temperature</p> <p>i) Recognise units of temperature in Fahrenheit and Celsius.</p> <p>ii) Solve real-life problems involving conversion, addition, and subtraction of units of temperature.</p>	
Unit 6: Unitary Method	
<p>6.1 Unitary Method</p> <p>i) Describe the concept of unitary method.</p> <p>ii) Calculate the value of many objects of the same kind when the value of one of these objects is given.</p> <p>iii) Calculate the value of a number of the same type of objects when the value of another of the same type is given.</p>	Unit 6
<p>6.2 Direct and Inverse Proportion</p> <p>i) Define ratio of two numbers.</p> <p>ii) Define and identify direct and inverse proportion.</p> <p>iii) Solve real-life problems involving direct and inverse proportion.</p>	
Unit 7: Geometry	
<p>7.1 Angles</p> <p>i) Recall an angle and recognise acute, right, obtuse, straight and reflex angle.</p> <p>ii) Use protractor to construct:</p> <ul style="list-style-type: none"> • a right angle, • a straight angle, • reflex angles of different measures. <p>iii) Describe adjacent, complementary, and supplementary angles.</p>	Unit 7



<p>7.2 Triangles</p> <ul style="list-style-type: none"> i) Define a triangle. ii) Define triangles with respect to their sides. iii) Define triangles with respect to their angles. iv) Use compasses and straightedge ruler to construct equilateral, isosceles and scalene triangles when three sides are given. v) Use protractor and straightedge ruler to construct equilateral, isosceles and scalene triangles when two angles and included side are given. vi) Measure the lengths of the remaining two sides and one angle of the triangle. vii) Define hypotenuse of a right angled triangle. viii) Use protractor and straightedge ruler to construct a triangle when two angles and included side are given. ix) Use protractor and straightedge ruler to construct acute angled, obtuse angled and right angled triangles when one angle and adjacent sides are given. 	Unit 7
<p>7.3 Quadrilaterals</p> <ul style="list-style-type: none"> i) Recognise the kinds of quadrilateral (square, rectangle, parallelogram, rhombus, trapezium, and kite). ii) Use protractor, set squares and straightedge ruler to construct square and rectangle with given side(s). 	
Unit 8: Perimeter and Area	
<p>8.1 Perimeter and Area</p> <ul style="list-style-type: none"> i) Recognise region of a closed figure. ii) Differentiate between perimeter and area of a region. iii) Identify the units for measurement of perimeter and area. iv) Write the formulas for perimeter and area of a square and rectangle. v) Apply formulas to find perimeter and area of a square and rectangular region. vi) Solve appropriate problems of perimeter and area. 	Unit 8
Unit 9: Information Handling	
<p>9.1 Average</p> <ul style="list-style-type: none"> i) Define an average. ii) Find an average of given numbers. iii) Solve real-life problems involving averages. 	Unit 9
<p>9.2 Block, Column and Bar Graphs</p> <ul style="list-style-type: none"> i) Draw block graphs or column graphs. ii) Read a simple bar graph given in horizontal and vertical form. iii) Interpret a simple bar graph given in horizontal and vertical form. iv) Define and organise given data. 	



Teaching Mathematics at Primary Level

Teaching the Strands

Following are the five strands of the National Curriculum:

- Number and operations
- Measurements
- Geometry
- Handling data
- Reasoning and logical thinking

The significance and integration of the above first 4 strands in teaching individual units of NCD Book 5 are discussed below, whereas the fifth strand is integrated in all the units. Specifically talking about the fifth strand, students validate answers with logical reasons by solving problems involving numbers and data. They also communicate and apply analytical reasoning about geometric shapes and figures.

1. Number and Number Operations

Enrich your teaching of 'place value' in relation to 7-digit and 8-digit numbers by asking your students to bring to class press clippings, magazine articles and other real-life references to big numbers. The Census data presented in NCD Book page 8 is one example of the plentiful material that exists about us all. With a firm grasp of place value, your students will also enjoy talking about even bigger 9-digit and 10-digit numbers; such as one billion (1 000 000 000) and its two distinct meanings. One thousand million in the International system and as one hundred crores (1 000 000 000) in Pakistan and some other parts of Asia.

'Rounding off' (pages 74 and 75) in New Countdown 5 lends itself very well to team games. Divide your class into rival teams, then ask each member to round off a given number, making sure you vary the multiple of 10 to which the number should be rounded off: '11 464 to the nearest 1000', '4545 to the nearest 10', and so on. Maintain a brisk pace of questioning, so that students learn to react quickly as well as accurately.

When introducing 'simplification', make sure every student sees (i) that the outcome of multi-operation sums varies according to the sequence in which their various parts are done, and (ii) that although there is no 'wrong' order of working out operations, the convention is to do them according to the DMAS sequence, thereby avoiding the confusion of several possible answers.

Make plenty of use of the board, presenting simple two-operation sums like those on page 14 and asking the students which part of the sum should be tackled first. The students can then copy and complete the sums in their exercise books. Progress to 3-operation and then 4-operation sums, again discussing the order of operations with the class. After this, brackets will naturally appear to students as 'helpers', simplifying the job of solving multi-operation problems by telling us what to do, and when.

In this part of New Countdown 5 we look in detail at two areas of primary-level maths which commonly present problems to young learners: 'multiplication and division', firstly in relation to 'common fractions' and secondly in relation to 'decimal fractions'. A large part of the difficulty is removed by paying close attention to the language in which these procedures are presented.

When your students begin to multiply with common fractions, it is essential that they understand exactly what is happening. Language, therefore, should be kept simple, and there should be no rush to impose 'rules' which may make little sense to students. I suggest that you begin with multiplication of fractions as repeated addition (see NCD Book page 42). For example, the students will quickly see that:

$$\frac{2}{5} + \frac{2}{5} + \frac{2}{5} = 3 \times \frac{2}{5} = \frac{3 \times 2}{5}$$

What happens, then, when we multiply a fraction by another fraction: On page 43 this idea is presented in a sequence of diagrams, each explained in the language of multiplication.

I recommend that you reproduce this exercise on the blackboard, explaining each stage slowly and carefully so that no student gets left behind.

Students will begin to see that the answer to the multiplication, say $\frac{1}{2} \times \frac{3}{4}$, can be obtained from $\frac{1 \times 3}{2 \times 4}$, a very important step.

Language is important at every stage of your discussion; when looking at the example: $\frac{3}{4} \times \frac{3}{5}$, emphasise that this multiplication asks us to find 'three-quarters of three-fifths', and draw a diagram on the board to illustrate the point. Multiplication with mixed numbers is the ideal moment for you to bring in the idea of cancelling, since numerators become large and unwieldy at this stage, and the purpose of cancelling—making multiplication simpler and quicker—is easily demonstrated.

Your success in teaching 'division by fraction' depends largely on the extent to which your students understand the concept and language of division. This is why, on page 51, we return briefly to the beginner's language of division and put students through some very simple exercises just to remind them of exactly what they do when they divide. This division language is then applied to a simple problem involving a common fraction divisor: $1 \div \frac{1}{4}$.

If you ask 'how many quarters make a whole?', the answer will come back loud and clear!

Progress to more complex calculations: 'how many sixths (of one whole) make 2 wholes?' 'How many twelfths (of one whole) make 9 wholes?'. By the time the students have completed the exercises, they will realize that they have been using multiplication to solve division problems. This is the moment to introduce the idea of reciprocal fractions. Students will now proceed quickly through the various stages of division with fractions, applying the language of division to their actions.

If they have to understand what happens when they multiply or divide with decimal fractions, and to handle calculations confidently, they must be able to multiply and divide by 10, 100, 1000 and so on. So start your teaching with some oral exercises or team games designed to test this ability: ask 'What is 492 multiplied by 100?' 'What is 48 300 divided by 10?' and so on. After this, the application of the same basic rules to decimal numbers should be plain sailing; again, reinforce written work with oral exercises.

Multiplication with decimal numbers should proceed carefully, according to the stages suggested in the book. Begin with a decimal number multiplier having tenths only. Show students that when they multiply together two decimal numbers with tenths only, this is the same as multiplying two whole numbers and then dividing the product by 100. The next step is to multiply with a decimal number having tenths and hundredths. If we turn each decimal number into a common fraction, it is easy to see that a decimal with tenths multiplied by a decimal with tenths and hundredths will produce a decimal product with tenths, hundredths and thousandths.

Dividing by a decimal fraction should pose few problems provided your students understand the equivalence: $(0.75 \div 0.25 = 3)$ is the same as $(7.5 \div 2.5 = 3)$ and $(75.0 \div 25.0 = 3)$ provided they can divide by 10, 100, 1000 (and so on) quickly and confidently.

When introducing 'percentages', be sure to establish the links between common fractions, decimal fractions and percentages, and avoid imposing 'rules' which students do not fully understand. New Countdown 5 presents percentages as a special kind of fraction.

All that students need to grasp is that instead of using common fractions having different denominators (for example, $\frac{1}{2}$; $\frac{3}{4}$; $\frac{7}{10}$), we turn these into fractions with the common denominator 100 ($\frac{50}{100}$; $\frac{75}{100}$; $\frac{70}{100}$), and instead of using decimal fractions written to different places of decimals (0.2; 0.03; 0.115), we turn them all into common fractions expressed in hundredths ($\frac{20}{100}$; $\frac{3}{100}$; $\frac{11.5}{100}$)

As Sadiq demonstrates on page 79, thinking of fractions in this way has several advantages: comparison becomes easier, and if we think of each fraction as a point on a scale numbered from 0 to 100, we can quickly get an idea of its size. Several pages of exercises designed to help students understand this basic equivalence precede the introduction of the word 'percentage' and the special symbol. Percentages are so much a part of everyday life that you will want to include plenty of activities, perhaps extending the idea of the reduction sale at local stores (NCD Book page 87) to a pretend sale of household items (10% off a thermos flask costing Rs 80, 15% off a camera costing Rs 800, and so on).

2. Measurements

Make sure you have a thermometer (ideally two thermometers: one Celsius, the other Fahrenheit) to show to the class during the discussion of 'temperature' and its measurement (page 109). Ask the students to record temperatures given in TV or radio weather bulletins over a 7-day period; these Celsius temperatures can then be converted into the Fahrenheit scale. For a reverse exercise, collect a list of temperatures recorded at various places throughout the world (many newspapers carry such listings in their business sections or supplements) and ask the students to convert these into Celsius. Find the hottest place and the coldest place in the world on a particular day and discuss how people respond to temperature in terms of clothing, housing, appearance, occupation and so on. Temperature thus becomes a way of linking up maths with science, geography and even history.

3. Geometry

In the geometry section, check that your students are using their 180° protractors correctly by asking them to first estimate (and jot down) what they think an angle is likely to measure before they actually measure it. If the students are reading the wrong set of markings, this procedure will quickly reveal the problem.

Try a real-life demonstration of 'Pencil and Pin' method of drawing a circle learnt previously and then graduate to a pair of compasses. Ensure that each student gets plenty of practice in the handling of compasses before asking the class to construct angles and triangles. They will then be well prepared to tackle the precision work of constructing triangles (NCD Book pages 137-145). Similar practice will be needed with the set square before students can construct squares and rectangles accurately and neatly.

4. Handling Data

The concept of 'average' is linked with column graph work, since column graphs help students to see that the average of a set of numbers is roughly half-way between the largest and smallest numbers of the set. Line graphs make a re-appearance to help illustrate the relationship between speed, distance and time; you may want to prepare additional graph worksheets here.

The introduction of the line graph provides an opportunity for exciting practical work. Give your students plenty of practice in reading data from simple line graphs, discussing why some graphs take the form of a straight line while others show variation. Ensure that all students have access to graph paper by the time you reach the drawing of graphs.

Before students attempt the exercise, make sure you have thoroughly discussed how the axes of the graph should be positioned and how the squares of graph paper should be used. Follow up this exercise with your own variants: for example, packets of pop-corn sold at a fun-fair over the course of a day; or the number of students entering a museum one Sunday afternoon.

Developing a Positive Attitude Towards Mathematics

To this point, the New Countdown series has been very useful in exposing students to new concepts. Apart from having learnt numbers and newer strategies for working with them, the students are now able to grasp new topics. They can now work independently and their minds are ready to absorb more. New Countdown 5 follows the same activity-based 'visual' format of the previous books in the series.

The primary aim of the **New Countdown** series is to ensure that every child develops a strong affinity for mathematics (as against a fear for it). And, for this, the following are necessary:

- A Tension-free and fun-filled atmosphere
- Concentration building
- Logical thinking
- A questioning mind
- Ability to answer without hesitation
- A retentive memory
- A sense of discovery (rather than 'being taught')
- Lateral thinking

Tension-Free and Fun-Filled Atmosphere

Such a learning environment establishes greater bonding between the students and the teacher and leads to healthier mental growth, greater confidence and better learning. Being in a comfortable, familiar, and friendly environment itself, builds confidence.

The more confident a child is, the easier it is for him or her to absorb new concepts, as the year progresses. It is firmly believed that students begin to get more joy by learning new concepts through discovery. If the lessons are based on such mores, there is no reason why the student will not grow up to be a happy and caring child with a bright, thinking mind.

Concentration Building

As students grow older, building concentration becomes imperative. Nothing helps more than a meditative mode in the morning to kick-start the power of concentration for the day. To keep them focused it is the teacher's responsibility to keep their lessons interesting and full of variety, include brain breaks or energisers to keep them engaged and attentive to create a visual environment, ask students to rate their work and keep an eye on managing time while executing lesson plans.

Logical Thinking

Every page in all the books in this series lays stress on logical thinking. The moment a child gets into 'logic' mode, thought, concentration and retentive memory will be the natural outcomes.

A Questioning Mind

If you want your students to be above-average achievers, encourage them to ask as many questions as they wish to. A question from one student will invariably lead to more questions from other students in the class. This is a very healthy outcome. There may be times when you do not have an immediate answer to a question; there is no need to be ashamed of this, as long as it is ensured that the answer is found within a day or two.

Ability to Answer Questions without Hesitation

It is important for a teacher to get into question-answer sessions with students, as often as possible. The mother of a well-known intellectual recently said that the reason for her son's brilliant performance in life was that he always asked too many questions and offered to give answers even when he was not specifically asked. The habit of trying to answer as many questions as possible should also be inculcated.

A Retentive Memory

Any kind of learning which is based on concentration, logical thinking, asking questions and finding answers will automatically lead to retentive memory. The power of retentive memory as a tool for learning at any stage in life can never be undermined.

Rote learning, uses two senses at the most—listening and seeing (reading), whereas activity-based learning, involves touching (doing) all the time, in addition to listening and seeing. The greater the number of senses used for a learning exercise, the better will be the concentration leading to improved speed of understanding, retention, logic, and application.

It would be great fun if the art and craft classes, off and on, incorporate mathematical shapes, concepts, and language. The joy that students derive out of such a learning experience is an added bonus.

A Sense of Discovery

Discovery is always more joyous than being told. If a mother tells her son that his teacher loves him, the son believes her, but if he discovers the teacher's love through a hug or a pat on the back, imagine the joy. The same applies to learning in Mathematics.

The sense of joy or pleasure at discovering new things, which is missing in rote learning, is a great accelerator for learning. Each discovery is the result of a practical activity.

Lateral Thinking

By this time students know several number facts and are comfortable with addition, subtraction, multiplication, and division. Concepts such as multiplication being a form of repeated addition, and division being a form of repeated subtraction, are used in everyday life without the necessity of going back to the basics. This is an example of lateral thinking.

Vertical learning would be to learn 2s tables, then 3s, then 4s and so on. Lateral thinking would entail understanding the facts behind the tables and applying these to solve everyday problems. In today's times, more than ever before, it is important that students think, learn to think and apply their knowledge laterally, i.e. they apply the knowledge gained from books to their environment, throughout the day.

Features of the Teaching Guide

The Teaching Guide contains the following features.



Suggested Time Frame

The guide provides a suggested time frame. However, every lesson is important in shaping the behavioural and learning patterns of the students. The teacher has the discretion to either extend or shorten the time frame as required.



Learning Curve

The guide identifies concepts taught earlier or, in effect, revises **prior knowledge**. Revision is essential, otherwise the students may not understand the topic fully.

The initial question when planning for a topic should be how much do the students already know about the topic? If it is an introductory lesson, then you can start with an interesting story, daily life example, use resources, or ask questions which could lead on to the new topic. In the lesson plan, the teacher can note what prior knowledge the students have of the current topic.

Each topic is explained clearly by the author in the textbook with detailed explanation, supported by worked examples. The guide defines the **specific learning objectives** of the topic. It will also outline the learning outcomes and objectives.



Real-life Application

Today's students are very proactive. The study of any topic, if not related to practical real-life, will not excite them. Their interest can easily be stimulated if we relate the topic at hand to real-life experiences.



Frequently Made Mistakes

It is important to be aware of students' common misunderstandings of certain concepts. If the teacher is aware of these, they can be easily rectified during lessons.



Summary of Key Facts

Facts and rules mentioned in the text are listed for quick reference.



Suggested Activities

Teaching guide provides you enough of suggested hands on activities for making lesson plan more interesting and engaging. Hands on activities will have more impact on student's learning.





Model Lesson Plan

Planning your work and then implementing your plan are the building blocks of teaching.

Teachers adopt different teaching methods/ approaches to a topic.

A model lesson plan is provided in every unit as a preliminary structure that can be followed. A topic is selected and a lesson plan written under the following headings:

Topic

This is the main topic.

Suggested Duration

Suggested duration is the number of periods required to cover the topic. Generally, class dynamics vary from year to year, so flexibility is important.

The teacher should draw his/her own parameters, but can adjust the teaching time depending on the receptivity of the class to that topic. Note that introduction to a new topic takes longer, but familiar topics tend to take less time.

Specific Learning Objectives

This identifies the specific learning objective/s of the topic being taught in a particular lesson.

Key Vocabulary

List of mathematical words and terms related to the topic that may need to be pre-taught.

Resources

This section includes teaching and learning resources used in a lesson plan. It could be objects and models, exercises given in the chapter, worksheets, assignments, and projects.

Strategy

Starter: Engagement Activity

The lesson can begin with something interesting, such as telling a story, relating a real-life experience or an everyday event which is related to the topic and is interesting enough to capture the attention of the students. Involving students in a discussion to find out how much knowledge do they have of the topic being taught is also a good strategy. You can use their own creativity to come up with idea/s to create a sense of fun.

Main Developmental Activity

Learning needs to start with practical activities. Therefore, the main developmental activity is the first step that leads to actual learning, which in turn leads to the required outcome of the lesson. This activity can be planned as individual work, pair or group work. Working individually creates self-confidence where the students enjoy a sense of

self-achievement, whereas pair and group activities create a sense of discovering and learning together.

These activities enhance concentration and improve retention of facts. Through these activities, these teacher can build understanding of concepts in a fun-filled way. It is easier for students to and then move from concrete to abstract.

Written Assignments

Finally, written assignments can be given for practice. It should be noted that classwork should comprise sums of all levels of difficulty, and once the teacher is sure that students are capable of independent work, homework should be handed out. For continuity, alternate sums from the exercises may be done as classwork and homework.

Supplementary Work (Optional): An activity or assignment could be given. It could involve group work or individual research to complement and build on what students have already learnt in class.

The students can do the work at home or in class and present their findings in class.

Wrap up

At the end of each lesson, summarise the whole lesson. Make sure wrap up should not be the repetition of lesson rather it should leave students with sense of accomplishment that they have learnt something new or important.



1

Numbers and Arithmetic Operations



Suggested Time Frame

10-12 periods



Learning Curve

Students have already worked with numbers up to 9 digits. Here they will deal with up to 10 digit numbers. Previously they have added and subtracted numbers up to 6 digit numbers. This lesson will lead them to add and subtract numbers of greater complexity. Students have already learnt about multiplication and division, now they will apply this knowledge to solve daily life problems involving mixed operations. They will also apply BODMAS rule to carry out combined operations.



Real-life Application

It would be useful to discuss some interesting situations where we may have to deal with big numbers in real-life. For example,

- Finding the number of words in a 200 page book with 37 lines per page and 8 words per line. On multiplication, we find that there would be $200 \times 37 \times 8 = 59\ 200$ words in the book.
- Finding the number of minutes a 97 year old man has lived. On multiplication, we find the number of minutes to be $97 \times 365 \times 24 \times 60 = 5\ 09\ 83\ 200$
- Finding the height of a certain mountain in inches! etc.



Frequently Made Mistakes

Students generally make mistakes when they add bigger numbers in expanded form, as they start the addition from the left side despite the fact addition should start from the right side i.e. from the ones column.

Students can make mistake when they deal with subtraction/ addition questions given in words, they need to be careful while placing one number under the other (correct place

value) in case of subtraction if given in words, the word FROM causes a confusion, and students generally write the number first which is written before the word FROM.

Students can also be confused by the BODMAS rule and its application with the arithmetic operation rule, so teachers should take time to ensure that the BODMAS rule is clearly understood by all.



Summary of Key Facts

- According to International Place Value Chart, commas are replaced by spaces.
- Columns should be written neatly and carefully while dealing with addition and subtraction of very big numbers with 7 or 8 digits.
- Zeros should be placed on the right and move the number towards the left, while multiplying a number with powers of 10.
- When a number is multiplied by 0, the result is 0.
- When a number is multiplied by 1 the result remains the same.
- Division is the inverse of multiplication.
- The number which is being divided is called the dividend.
- A number by which another number is to be divided is called the divisor.
- Quotient is the quantity produced by the division of two numbers.
- The number which is left over after the division is complete is called the remainder.
- When we have problems with two or more of the four operations without brackets, the rule of DMAS should be used for simplification.
[Tip: A simple mnemonic to remember DMAS, 'Do Musicians Always Sing?']
- Brackets are also called grouping symbols, brackets help us to solve problems involving two or more operations by telling which part to simplify first.



Suggested Activities

1. Activity: Pair Work

Learning Outcome: Combined operations using the BODMAS rule.

Resources: Paper slips, Whiteboard, marker

Instructions:

- Divide the class into pairs.
- Ask each pair to think of any number from 2 to 9.
- Instruct them to use the same number with parenthesis () and one or more operations to get an answer equal to 1.

For example, four 4s or four 3s, as shown below:

$$(4 \div 4) + 4 - 4 \text{ or } (3 - 3) + (3 \div 3)$$

- Similarly, find an expression to get an answer equal to 0.
- If students are unable to get 1 as an answer then assist them.

2 Activity: Individual/ Pair Activity

Learning Outcome:

- Addition/ subtraction of numbers of complexity and of arbitrary size.
- Multiplication/ division of numbers up to 6 digits by 10, 100, and 1000.

Resources: Activity Cards

Instructions:

- Provide each student with an activity card with questions on any of the four operations. This activity can be used for addition or subtraction of complex numbers and multiplication/ division of numbers up to 6 digits by 10, 100, and 1000.
- Time the activity and get the activity cards peer checked.

Sample Activity Cards:

Complete this addition square. Add the rows and columns to find the total:		
1984623	2015246	
3407862		
	1374109	

Find the difference between these two of numbers:

1496953

205343

Write the missing numbers:

a) $486238 \times \underline{\hspace{2cm}} = 48623800$

b) $0.07 \times \underline{\hspace{2cm}} = 7$

c) $\underline{\hspace{2cm}} \div 1000 = 0.0069432$

d) $387200 \div 10 = \underline{\hspace{2cm}}$

e) $\underline{\hspace{2cm}} \times 100 = 9413$

3. Activity: Group Work

Learning Outcome: Read/ write numbers up to 1 000 000 000 (one billion) in numerals and words.

Resources: Number cards

Prepare two sets of number cards. Write 7 or 8 digit numbers in figures on one set and the same number in words on the other set.

Instructions:

- Distribute number cards among the students.
- Ask one student to show his/her card to the class. If the card has a number written in figures tell other students to quickly check who has a matching card of the same number written in words and read it loud and clear. Similarly, if the number is written in words, students will find a matching card of the same number written in figures.
- Stick the pair of cards on the board.
- Repeat the activity till all cards have been paired.



Model Lesson Plan

Topic

Place value

Duration

2 Periods

Specific Learning Objectives

By the end of the lesson students will be able to add and subtract numbers of complexity.

Key Vocabulary

addition, subtraction

Resources

Whiteboard, marker

Strategy

Starter: Engagement Activity (5 mins)

Math Game Double Trouble

Tell students to use their whiteboard for this activity. Call out a 4-digit number and ask them to double it. Once they have, tell them to double the answer. Repeat doubling of numbers till they reach a 7 or 8 digit number.

Main Developmental Activity

Teacher's Exposition (20 mins)

Explain that when we buy or sell expensive things, such as property or prepare a budget for government projects we deal in bigger numbers.

Example:

Sana bought property worth Rs 31536000 and her brother Ali bought property worth Rs 31341200. Who has spent more money and how much more?

$$\begin{array}{r} \text{Rs } 31536000 \\ - \text{Rs } 31341200 \\ \hline \text{Rs } 194800 \end{array}$$

Sana spent Rs 194800 more than her brother

Activity (10 mins)

Tell students to work in pairs.

Give newspaper cutting to them which have bigger number used in daily life situation.

Ask them to choose any to 7 or 8 digit numbers and add and subtracts them.

Written Assignments (40 mins)

Ex 1b Q4 (a, b, c), Q7 (a, b, c), Q11

Wrap up (5 mins)

End the lesson by asking students, where do you see addition and subtraction of complex numbers in real-life? Give any two examples.

2

HCF and LCM



Suggested Time Frame

10-12 periods



Learning Curve

Students already know how to find common multiples of numbers and least common multiple by prime factorisation. Thereafter, they will now find the LCM by the division method. Students have already learned how to find common factors of a number and the highest common factor by prime factorisation and Venn diagram. They will now learn to find the HCF by the long division method. Students will further apply the knowledge of LCM and HCF to solve real-life problems.



Real-life Application

- HCF is used to find whether an event will repeat again and again. HCF is also used to divide two or more objects into equal points or split things into smaller equal sections. For example, if there are 21 students from Grade 4 and 28 students in Grade 5 and the teacher wants to arrange students in minimum rows, she/he will calculate the HCF of 21 and 28. Since the HCF is 7, Grade 4 students will be arranged in 3 rows and Grade 5 in 4 rows.
- LCM is used to find whether an event will happen repeatedly at the same time. LCM is important to solve problems related to racetracks, traffic lights and load shedding etc. For example, if there is a race among three students on a circular track, and student A covers the track in 4 minutes, student B covers the track in 5 minutes and student C covers the track in 10 minutes, all starting from the same point, after what time will all three of them be at the starting point again?



Frequently Made Mistakes

Students often get confused in recognising events which are related to HCF and LCM in word problems.



Summary of Key Facts

- Rules of divisibility of 4, 6, 8, and 9.
- A number is divisible by 4 if the number formed by the last two digits of the number is divisible by 4.
- A number is divisible by 6, if it is an even number and the sum of its digits is divisible by 3.
- A number is divisible by 8, if the number formed by the last three digits is a multiple of 8 or there are zeros at its hundreds, tens and ones places.
- If the digits of any number add up to a number which is exactly divisible by 9, then the original number is also divisible by 9.
- HCF stands for highest common factors.
- LCM stands for lowest common multiple.
- HCF and LCM can be found by prime factorisation and division methods.
- The LCM of the given numbers is the product of all the prime factors including the common factors used only once.
- The product of two numbers is equal to the product of their HCF and LCM.



Suggested Activity

Starter: Engagement Activity

Provide each student or each pair with a quiz card. Time the students and then swap the cards with other student or pair for peer checking. This activity saves time and is helpful for quick revision of prior concepts.

Quiz Card Sample:

1. The prime factors of 24 are _____
2. $5^3 =$ _____
3. Circle the number which is not a factor of 40.
2 4 5 6 8 10
4. List all the prime numbers between 20 and 40.
5. Which number can evenly divide 81?

Main Developmental Activity (Teacher's Exposition)

Learning Outcome: Find HCF of the given numbers.

Resources: Counters

Instructions:

- Use two sets of counters, each of a different color, for the two given numbers.
- Arrange the two sets of counters on either side of a demarcation line: for convenience, we may take the smaller number of counters on the left and the larger on the right.
- Arrange the counters on the left in a vertical line.
- Ask the children to justify this arrangement. The reason, as we know, is that HCF is always lesser than or equal to the greatest factor of the smaller number.
- Now arrange the ones on the right in as many rows as there are on the left. If you are able to arrange these in a rectangle, then the number of rows in the arrangement is the required HCF.
- If such an arrangement is not possible, change the arrangement on the left to the next possible rectangular arrangement, and then accordingly change the arrangement on the right as well.
- When both the sides are in a rectangular arrangement with the same number of rows, the number of rows is the HCF.

For example, let us try to find the HCF of two numbers, 6 and 20.

In the first step, we arrange 6 counters in a vertical line to the left of the demarcation line (Line of Control!).

We now arrange the 20 other counters on the right. We find that we cannot arrange these in a rectangle (Fig. 1). So 6 is not the HCF of 6 and 20.

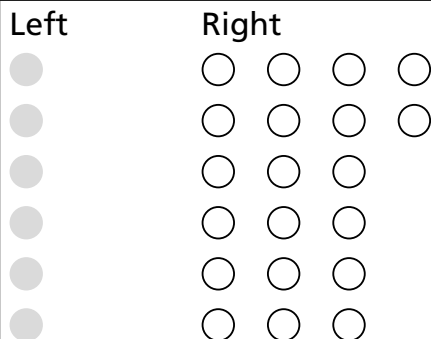

Fig. 1

We now change the arrangement on the left to three rows of two counters each.

Then we change the arrangement of the 20 counters.

Again we find that these do not form a rectangle (Fig. 2).

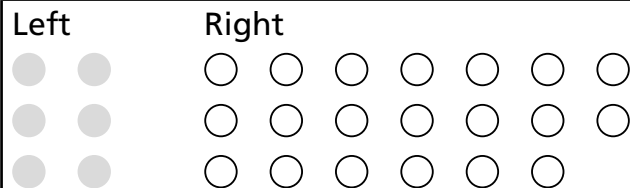

Fig. 2

The next step is to change the arrangement on the left yet again into two rows of three counters each.

Now we find that we can arrange the 20 counters in two rows.

Left



Right

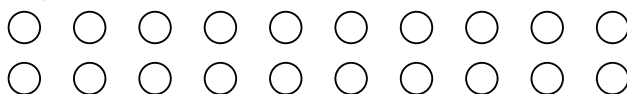

Fig. 3

Therefore, 2 is the HCF of 6 and 20 (Fig. 3.c).

In case of three numbers, we use two demarcation lines and three different coloured sets of counters.

Main Developmental Activity (Teacher's Exposition)

Learning Outcome: Find LCM of given numbers.

Instruction:

Write 3, 4, and 6 on board and ask the students to find the numbers which are divisible by all these numbers.

(Hints: When we find the product of all three numbers i.e. $3 \times 4 \times 6 = 72$, it is clear that 72 is divisible by 3, 4, and 6 since 72 is the product of these numbers.)

Ask the students, "Is 72 the smallest number that is divisible by 3, 4, and 6?"

After collecting response from students, explain how 12 is the smallest number that is divisible by 3, 4, and 6 simultaneously. Hence conclude that the smallest number that is divisible by all given numbers is called LCM or least common multiple.

Introduce the two ways by which we can find the LCM of the given numbers i.e. prime factorisation method and division method by solving examples on the board. Later on, give them practice questions to solve and assess their understanding.

1. Activity: Individual Work

Learning Outcome: Factors of the given numbers

Resources: Bottle tops

Instructions

- Give each student a specific number of bottle tops.
- Ask students to arrange them in all possible rectangular arrays.
- The bottle tops should be arranged in rows. Single straight lines, both horizontal and vertical, are also acceptable.
- Each time a rectangle is formed, the number of rows is a factor of the given number.
- When it is not possible to arrange the given bottle tops in a rectangular form, shift bottle tops one by one from the end to form a new row.

For example, to find all possible factors of six, we arrange the bottle tops as shown in the following figures.

Fig. 1 shows six bottle tops in a single row. Therefore, 1 is a factor of 6.



Fig. 1

Fig. 2 shows two rows with 3 tops in each row. A rectangle is formed therefore, 2 is a factor of 6.



Fig. 2

Fig. 3 shows 3 rows with 2 tops in each row. Since a rectangle is formed with three rows, 3 is a factor of 6.



Fig. 3

Fig. 4 shows no rectangle is formed with 4 tops in a column and 2 tops in a row, therefore, 4 is not a factor of 6.

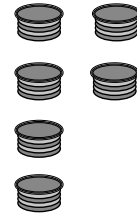

Fig. 4

Fig. 5 shows 2 bottle tops in the first row and 1 in each of the remaining rows. No rectangle is formed, therefore, 5 is not a factor of 6.

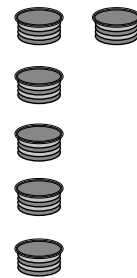

Fig. 5

Fig. 6 The next possible rectangular arrangement is a vertical line with six rows. Therefore, 6 is a factor of 6.



Fig. 6

Extended Work: We can also ask the students to check whether a given number is prime or not using this method. The reason is that no rectangular form other than a single horizontal or vertical line is possible for a prime number.

2. Activity: Pair Work

Learning Outcome: Finding HCF of given numbers.

Resources: 2 dice per pair of students, paper, pen or pencil

Instructions:

- Divide the class into pairs.
- Give each pair two dice.
- Instruct each student to roll the pair of dice and form a 2-digit number using the numbers on the dice.
- Ask the students to find all the factors for their numbers and write them down on a sheet of paper.
- Next ask them to compare their factors and calculate the HCF of the two numbers.
- Let the students follow the same steps for more numbers.
- The same activity can be used for LCM as well.

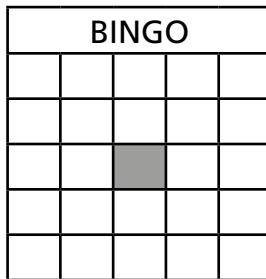

3. Activity: Individual Work

Learning Outcome: Find HCF of two numbers.

Resources: Blank Bingo card, pen or marker

Instructions:

- Give one blank Bingo card to each student.
- Instruct students to fill in their card with numbers from 1 to 25.
- Ensure they use a pen or marker so that numbers cannot be changed during the game.
- Make sure each child has filled in his/her card before you start the game.
- Play the game by calling out pairs of numbers and instructing students to cross out the HCF of this pair.
- Make sure to note down the numbers and their HCF as you call them out so you can use it to cross-check the students' Bingo cards when they're done.
- Give the students time to calculate the HCF for each pair as you play the game.
- You might want to prepare the list of numbers beforehand so that you don't end up with the same HCF for multiple pairs.
- The first student to cross out all four numbers in a row or column wins the game.



Model Lesson Plan

Topic

Highest Common Factor (HCF)

Duration

2 periods

Specific Learning Objectives

By the end of the lesson students will be able to find the HCF of 3 sets of double digit numbers using the long division method.

Key Vocabulary

factors, common factors, highest common factors (HCF)

Resources

Chart papers, markers



Strategy

Starter: Engagement Activity

Mental maths (5 mins)

A quick recall of dodging times-tables up to 12 orally.

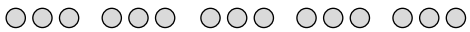
Begin the lesson with small numbers and counters. Tell the students that any number of counters that can be grouped in smaller sets (without leaving a remainder) is a factor of the larger number. For example, 15 counters can be arranged in either of the following ways:

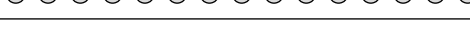
1		$5 \times 3 = 15$
2		$3 \times 5 = 15$
3		$1 \times 15 = 15$
4		$15 \times 1 = 15$

Children 'see' how the numbers 3 and 5, 1 and 15, are factors of 15. Several similar examples will serve to make the concept clearer.

Main Developmental Activity

Group Work (20 mins)

Divide the class into groups and provide each group with three sets of 2-digit numbers and the following rules or steps to find out the HCF. For example:

Group 1: Find the HCF of 18, 27, and 45.

Instructions:

Step 1: Taking the bigger number 27 as the dividend and the smaller number 18 as the divisor, division is carried out:

$$\begin{array}{r} 1 \\ 18 \overline{) 27} \\ \underline{-18} \\ 9 \text{ remainder} \end{array}$$

Step 2: The remainder 9 obtained in the previous step becomes the new divisor and the old divisor 18 becomes the new dividend and division is carried out again. There is no remainder here.

$$\begin{array}{r} 2 \\ 9 \overline{) 18} \\ \underline{-18} \\ 0 \text{ remainder} \end{array}$$

Step 3: Step 2 is repeated. Since there is no remainder of division is carried out with the biggest number 45 as a dividend and 9 as a divisor.

$$\begin{array}{r} 5 \\ 9 \overline{) 45} \\ \underline{-45} \\ 00 \text{ remainder} \end{array}$$

Hence, the HCF of 18, 27, and 45 is 9.

Feedback (10 mins)

Ask each group to share their solution and explain each step in detail. Discuss the practical application of HCF in daily life.

Written Assignments (40 mins)

Ex 2b Q6 (a to e)

Wrap up (5 mins)

1. Is there any other method to find the HCF?
2. Give one example of HCF from daily life.

3

Fractions



Suggested Time Frame

8-10 periods



Learning Curve

Students already know how to apply four operations on 'like fractions' and they have also verified the commutative and associative law of addition and multiplication. Here, they will apply the four operations on 'unlike fractions', which will lead them to solve real-life problems involving fractions. They will be also be able to apply the BODMAS rule while simplifying expressions involving fractions.



Real-life Application

Fractions are used:

- in baking to tell what quantity of an ingredient to use.
- in telling time; each minute is a fraction of the hour.
- on a doctor's prescription to tell how much of a medicine should be taken.



Frequently Made Mistakes

Students make the following mistakes:

- While simplifying fractions they sometimes use two different factors of the same number for cancellation.
- When multiplying two fractions they cancel both numerators or both denominators by the same factor, instead of cancelling the numerator with the denominator.

For example. $\frac{4}{7} \times \frac{28}{35}$

- When dividing fractions, they find the reciprocal of the first fraction instead of the second fraction.



Summary of Key Facts

- In proper fractions the numerator is smaller than the denominator.
- In improper fractions the numerator is greater than the denominator.
- A mixed fraction is made up of a whole number and a proper fraction.
- A fraction can be reduced to the lowest term by dividing the numerator and denominator by the common factor.
- To add and subtract, make the denominators the same.
- To multiply fractions, reduce them to the lowest term, then multiply the numerator with the numerator and the denominator with the denominator.
- Commutative, associated, and distributive laws are true and can be verified for fractions.



Suggested Activities

1. Activity: Individually, in pairs or in groups

Learning Outcome: Express values in fractions.

Resources: Paper, Pencil, Wastepaper basket, Ball, Whiteboard, Marker

Instructions:

- Divide the class into pairs.
- Mark a throw spot and keep the wastepaper basket at least 6 feet away from it.
- One student in each pair will try to throw the ball in the basket 5 times and his/her partner record the score. Then tell them to switch their roles.
- Each pair will express the recorded values of their hits and misses in fractions on the whiteboard.
- Take feedback from each pair.

2. Activity: Individual Work

Learning Outcome: Revision of like and unlike fractions

Resources: Activity Cards

Give each student an activity card to gauge their prior knowledge about fractions. (5 minutes)

Sample Activity Card

Draw a line to join the matching pairs of fractions.			
$1\frac{1}{3}$	$\frac{8}{5}$	$2\frac{2}{3}$	$\frac{6}{5}$
$2\frac{1}{3}$	$\frac{11}{5}$	$2\frac{1}{5}$	$\frac{8}{3}$
$1\frac{3}{5}$	$\frac{7}{3}$	$1\frac{1}{5}$	$\frac{4}{3}$

3. Activity: Individual Work

Learning Outcome: Find the lowest common denominator.

Resources: Index cards, Permanent marker

Instructions:

- Write 20 different fractions on as many index cards, but most of these numbers should NOT be prime numbers. Mix up smaller numbers (within 1 and 20) with a few larger ones with a lot of factors.
- Divide the cards into 2 piles of 10 and give them to each pair.
- At the word "Go!" each player turns up one card in their pile and places it in the center of the table.
- The goal of the game is to calculate the lowest common denominator of both cards and say it aloud.
- The first player to call out the correct numbers wins the round.
- Repeat the above steps for subsequent rounds.

4. Activity: Individual Work

Learning Outcome: Add and subtract fractions.

Resources: Fraction Puzzle activity sheet

Instructions:

- Recall how to add and subtract fractions by writing questions on the board. Remind students to reduce their answers to the lowest terms.

Examples:

Addition:

a. $\frac{2}{5} + \frac{1}{5} = \frac{3}{5}$

b. $\frac{1}{3} + \frac{1}{6} = \frac{2}{6} + \frac{1}{6} = \frac{3}{6}$ or $\frac{1}{2}$

Subtraction:

a. $\frac{5}{6} - \frac{1}{6} = \frac{4}{6}$ or $\frac{2}{3}$

b. $\frac{7}{8} - \frac{1}{4} = \frac{7}{8} - \frac{2}{8} = \frac{5}{8}$

- Distribute the activity sheets to each student.
- Explain that students should solve the puzzle by adding or subtracting fractions across and down.
- When everyone is done with their work, discuss the answers as students check their work.

Fraction Puzzle

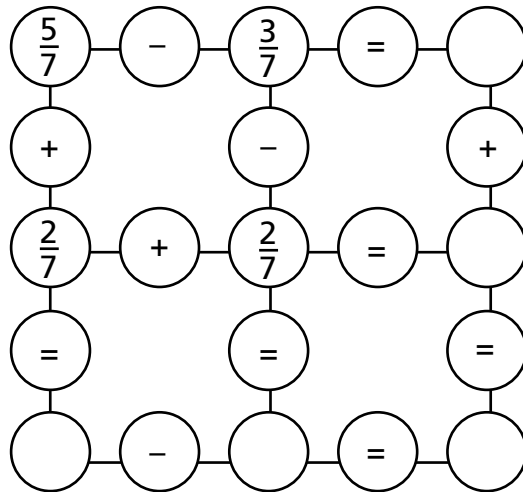

Model Lesson Plan

Topic

Fractions

Duration

2 Periods

Specific Learning Objectives

By the end of the lesson students will be able to add and subtract fractions with different denominators.

Key Vocabulary

numerator, denominator, like fractions, unlike fraction

Resources

Worksheet

Strategy

Starter: Engagement Activity (5 mins)

Recall

Write two fractions on the board $\frac{1}{8}$, $\frac{2}{4}$ and ask students which fraction is bigger and why?

Main Developmental Activity

Teacher's Exposition (15 mins)

Draw the following diagram on the board and explain to the students that they cannot add or subtract these fractions because they have different denominators. In order to add these fractions we need to make the denominators the same; we need to take out the LCM. Hence the LCM of 8 and 4 is 8.

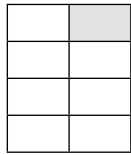

$$\frac{1}{8}$$

+

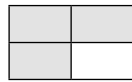

$$\frac{3}{4}$$

$$\frac{1 \times 1}{8 \times 1} + \frac{3 \times 2}{4 \times 2}$$

$$\frac{1}{8} + \frac{6}{8}$$

Since, the two fractions now have the same denominator, they can easily be added together.

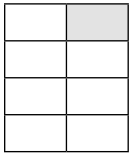

$$\frac{1}{8}$$

+

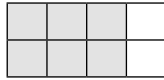

$$\frac{6}{8}$$

=

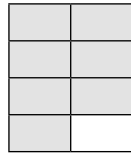

$$\frac{7}{8}$$

Individual Work (15 mins)

- Write down a few sets of fraction sums on the board.
- Let the student work in pairs. For example,

$$\frac{1}{3} + \frac{3}{4} + \frac{1}{6}$$

$$\frac{5}{8} + \frac{1}{4} + \frac{1}{2}$$

$$\frac{4}{6} + \frac{1}{2} + \frac{2}{3}$$

$$\frac{7}{8} + \frac{1}{2} + \frac{3}{4}$$

- Tell each pair to choose two different sums and that both of them should solve one each on the worksheet.

Instructions	Solution
<ol style="list-style-type: none"> 1. Write down the question. 2. Make the denominator the same. 3. Add the fractions 4. Simplify your final answer. 	

Peer Checking

Worksheets will be checked by peers. While the students are peer checking, the teacher solves the sums on the board. Discuss possible errors and answer their queries. Students will do the correction on their own worksheet.

Written Assignments (40 mins)

Ex 3a Q4 (a, c, e) Q5 (a, c, e).

Wrap up (5 mins)

Ali and Sana bought two medium size pizzas. Ali cuts his pizza into 4 equal slices and Sana cuts the pizza into 3 equal slices. Ali ate two slices and Sana ate two slices, who is left with more pizza? Discuss the strategies to solve the problem.

4

Decimal and Percentages



Suggested Time Frame

8-10 periods



Learning Curve

In the previous Grade, students have already used the decimal point when working with money. They have already learnt to apply four operations on numbers. They can convert decimals to fractions and vice versa. This knowledge will further lead them to add and subtract decimal numbers, and multiply and divide a decimal number by 10, 100, and 1000 and with a whole number. Furthermore, they will use division to change fractions into decimal numbers, simplify decimal expressions involving brackets, and round off decimals. They will be able to recognise percentage as a special kind of fraction and convert percentages to fractions and to decimals and vice versa. Students will be applying all the above mentioned knowledge when they solve real-life problems.



Real-life Application

- We use decimals in every day life while dealing with money, weight, length etc.
- Decimal numbers are used in situations where more precision is required than the whole numbers can provide. For example, when we calculate our weight and height.
- Shops advertise discounts on products. These discounts are in percentages.
- Banks quote interest charged to the clients on loans, or interest paid for money invested, as a percentage.
- Companies describe their success or failure as an increase or decrease in percentage of their profits.
- Marks sheets also represent students' marks in percentages.
- Antiques or jewelry may increase in value as time goes by; we usually express that increase as a percentage.
- Items such as equipment and machinery usually decrease in value. We express that decrease as a percentage.



Frequently Made Mistakes

- When adding or subtracting decimal numbers, students forget to put the decimal point in the correct place.
- When multiplying or dividing fractions they don't remember whether the decimal appear to move towards the right or left (although the decimal point does not move).



Summary of Key Facts

- It is important to write sums neatly, with the decimal point and the columns properly aligned.
- 'Unlike decimals' are numbers with different decimal places.
- Numbers with the same number of decimal places can be easily added or subtracted by writing each digit under the other.
- It is important to keep in mind that whenever you multiply or divide by a whole number, you count from the extreme right of the decimal fraction the number of places after which the decimal point is placed in the multiplicand or dividend, and then mark it exactly in the same place in the product and quotient respectively.
- *Multiplying decimal fractions by 10 and its multiples:* Students know that when they multiply a whole number by 10, 100, or 1000, the number jumps one, two, or three column(s) to the left respectively. A decimal fraction also moves in the same direction, corresponding to the number of zeroes in the multiplicand.
- Another way of working out such problems is to count the number of zeros in the multiplier and then shift the multiplicand the same number of zeros to the left or, alternatively, shift the decimal point the same number of places to the right. No need to actually multiply.
- *Dividing decimal fractions by 10 and its multiples:* When a number is divided by 10, its value decreases whether it is a whole number or a decimal number.
- Multiplication gives a bigger number as the answer while division gives a smaller number as the answer. So, move your decimal point accordingly.
- *Multiplying a decimal fraction by a decimal fraction:* In order to multiply two numbers with decimals, it is easy to change the numbers into common fractions and then multiply them.
- *Dividing a decimal fraction by a decimal fraction:* In order to divide two numbers with decimals, it is easy to first change the numbers into common fractions and continue dividing as would be done in the case of fractions.
- The same number of decimal places in the numerator and denominator means that the 'decimal points' can be ignored. In other cases, we multiply the dividend and the divisor with 10s or 100s, as need be, to change them into whole numbers and then proceed to divide them as usual. But, we need to re-introduce the decimal and decimal place numbers after the calculations.

- When a decimal number is multiplied by 10, 100, and 1000, apply the same rule as for whole numbers; move one column to the left.
- When a decimal number is divided by 10, 100, and 1000, count the zeroes in the divisor, then shift the dividend the same number of columns to the right.
- Apply the BODMAS rule to simplify the decimal sums where two or more operations are used.
- Rounding off means making an estimate but maintaining its value close to the original figure.
- To round off a whole number to its nearest 10, we look at the ones digit. If it is less than 5, we round it down and if it is equal to 5 or greater than 5, round it up.
- Rounding off and approximation is especially useful when adding, subtracting, multiplying, and dividing a group of numbers.
- Always keep in mind that half way numbers are to be rounded upwards. The numbers with a decimal can also be rounded off to the nearest whole number by using a number line.
- The word 'percentage' is based on the Latin word 'Centum'. A percentage is a special kind of a fraction with 100 as a denominator.
% is the symbol used for percentage, which means 'per cent' or 'upon 100'.
- To change a percentage into a decimal, first convert it into a common fraction and then express it as a decimal.



Suggested Activities

1. Activity: Individual Work

Learning Outcome: Add/ Subtract decimals.

Resources: Magic number puzzle

Instructions:

- Provide each student with a magic number puzzle (sample given) to solve. Let them figure out on their own how to solve the puzzle.
- Solve the magic number puzzle below. Each row, column, and diagonal line must add up to 5.5.

2.4		
1.2	2.7	

2. Activity: Individual Work

Learning Outcome: Calculate percentage of the given number

Resources: Number cards (1 to 9) 2 dice, Paper and pencil

Instructions:

- Shuffle the card and place then face down in the center of the table.
- Invite one player to turn over a card.
- Explain that the players must add zero to the card in order to calculate the percentage. For example, if they draw a 9, they need to calculate 90%.
- Now, invite the second player to roll the dice.
- Next, the players must quickly add up the total of the 2 dice and calculate the appropriate percentage. For instance, if the total of the dice is 8, they must calculate 80% of 8.
- The player who arrives at the correct answer first wins the round.

3. Activity: Pair Work

Learning Outcome: Solve real-life problems involving percentages.

Resources: Whiteboard, marker, Activity sheet

Instructions:

- Divide the class in pairs.
- Give any question to each pair to solve:

Example: Sara gets a monthly pocket money of Rs 2000. She keeps half of it for her daily expenses and decides to go shopping with the rest. She liked a dress on a 35% sale, originally worth Rs 1500. Can Sara afford the dress on sale?

4. Activity: Individual Work

Learning Outcome: Convert percentages to fractions and to decimals or vice versa.

Resources: Activity sheets

Instructions:

Provide the students with the following activity sheet to solve individually and get it peer checked.

Percentage	Fraction	Decimal
50%		
	$\frac{3}{4}$	
		8.5
20%		

5. Activity: Individual Work

Learning Outcome: solve real-life problems involving percentages

Resources: Whiteboards, markers

Instructions:

- Ask the students to research about their favorite cricketer and bring information related to his number of matches played, runs scored, wickets taken in ODIs and Test Matches.
- Then ask the students to express their findings in terms of percentages.

Example: Samiullah took 364 wickets in Test Matches and 182 wickets in the ODIs overall in his career.

The percentage of his wickets taken in the test matches is:

$$\frac{364}{544} \times 100 = 66.91\% \text{ or } 67\%$$

And that of his wickets taken in ODIs is:

$$= 100 - 67 = 33\%$$



Model Lesson Plan

Topic

Percentage

Duration

2 periods

Specific Learning Objectives

By the end of the lesson students will be able to convert fractions into decimals and percentages.

Resources

Grids with 100 squares (10 × 10), coloured Buttons

Key Vocabulary

percentage, fraction, decimal

Strategy

Starter: Engagement Activity (5 mins)

The teacher can start the lesson by distributing counters (equal amounts to each group) and 100-square grids among groups of students. The students in each group first segregate the counters according to their individual colour preference and then fill up each small square on the grid with a counter.

Main Developmental Activity

Teacher's Exposition (15 mins)

Once students are done with the engagement activity, ask each group to write down the number of squares occupied by each colour as a fraction by preparing a table in the

format shown below. Since any fraction with a denominator of 100 can be expressed as a percentage, all these fractions can be easily expressed as a percentage.

Now explain that if we divide the numerator by the denominator we will get a decimal number and if we multiply the fraction by 100, we have expressed it as a percentage.

For example,

$$\frac{15}{100} \times 100 = 15\%$$

Group Work (10 mins)

	Fraction	Decimal Fraction	Percentage
Red: 15 out of 100	$\frac{15}{100}$	0.15	15%
Yellow: 20 out of 100	$\frac{20}{100}$	0.20	20%
Blue: 17 out of 100	$\frac{17}{100}$	0.17	18%
Pink: 35 out of 100	$\frac{35}{100}$	0.35	35%
White: 13 out of 100	$\frac{13}{100}$	0.13	13%

Percentages are useful while comparing unlike fractions. These fractions are converted into equivalent fractions having 100 as their denominator.

Written Assignments (40 mins)

Ex 4c Q6 (a to e), Q7 (a to e)

Wrap up (5 mins)

Discuss what steps are needed to calculate percentages from fractions. Ask if Ali scores 20 marks out of 25 in maths, what is his percentage in mathematics? Can we convert percentages into decimals? If yes, then how?

5

Distance, Time, and Temperature



Suggested Time Frame

8-10 periods



Learning Curve

Students have already worked with units of length in their previous class. They are well aware of addition, subtraction and conversion of units of length and this will lead them to add and subtract measure of distance. Furthermore, the knowledge about conversion of units of time will help them to add, subtract and convert years to months, months to weeks, weeks to days, and vice versa. Next, they will recognise units of temperature in Fahrenheit and Celsius. Students will be able to apply the knowledge of conversion, of units of distance, time and temperature, in real-life situation.



Real-life Application

- Distance is a numeral measurement which can be used to tell how far one object is from other.
- Time is used everywhere while travelling, working and cooking.



Frequently Made Mistakes

- A common mistake while converting one unit to the other, students use the wrong conversion unit and the wrong operation. Students forget that we 'multiply' while converting a bigger unit to a smaller unit (e.g. $5 \text{ m} = 5 \times 100 = 500 \text{ cm}$).

On the other hand we 'divide' when converting a smaller unit to a bigger units (e.g. $200 \text{ cm} = 200 \div 100 = 2 \text{ m}$)



Summary of Key Facts

- Kilo means 1000, centi means $\frac{1}{100}$ and milli means $\frac{1}{1000}$.
- When a bigger unit is to be converted to a smaller unit: **MULTIPLY**.

- When a smaller unit is to be converted to a bigger unit: DIVIDE.
- $1 \text{ km} = 1000 \text{ m}$, $1 \text{ m} = 100 \text{ cm}$ and $1 \text{ cm} = 10 \text{ mm}$.
- When hours are converted to minutes multiply by 60. When minutes are converted to hours divide by 60.
- When minutes are converted to seconds multiply by 60. When seconds are converted to minutes divide by 60.
- One hour = 60 minutes, half an hour = 30 minutes, quarter of an hour = 15 minutes and three quarters of an hour = 45 minutes.
- Midnight to noon makes 12 hours.
- There are 24 hours in a day, 7 days in a week, 52 weeks in a year and 12 months in a year.
- Two common calendars are solar and lunar calendars.
- April, June, September and November have 30 days, the rest of the months have 31 days except February which has 28 days, and 29 in each leap year.



Suggested Activities

1. Activity: Individual Work

Learning Outcome: Conversion of measures of distance.

Resources: Activity Cards

Instructions:

For the conversion of metres into centimetres we multiply by 100.

Conversion of measures of distance

1. Jawad is going to distribute Eid sweets in his neighborhood. He walks 20 metres to the first house. How many centimetres did he walk?

Answer: _____

2. He walks 100 metres to the next house. How many centimetres did he walk? How many millimetres did he walk?

Answer: _____

3. He walks 4500 centimetres to the next house. How many metres did he walk?

Answer: _____

4. He can't make it to the next house because it's 2000 metres away. How many kilometres is it?

Answer: _____

2. Activity: Pair Work

Learning Outcome: Solve real-life problems involving conversion, addition, and subtraction of time.

Resources: Activity Sheets

Instructions:

- Divide the class into pairs.
- Explain how to convert units of time.
- Tell each pair to solve the worksheet and then get it peer checked by exchanging them. (One question as an example is done for you)

What Day & Time is it?

<p>1. Yousuf decides to start practicing for his Maths exam on Friday at 3:15 p.m. which is due after the weekend.</p> <p>Day: Friday Time: 3:15 p.m.</p>	<p>2. 5 hours later he gets bored and decides to take a break for dinner.</p> <p>Day: Time:</p>	<p>3. 15 hours later he picks up his science book and starts reading the new topic his teacher gave him for homework.</p> <p>Day: Time:</p>
<p>After 2 hours he decides to take a break for lunch.</p> <p>Day: Time:</p>	<p>0.5 hours later he takes a nap for 45 minutes.</p> <p>Day: Time:</p>	<p>He goes for a bicycle ride with his friends for an hour at the same time next day.</p> <p>Day: Time:</p>

3. Activity: Individual/Pair Work

Learning Outcome: Add and subtract measures of distance

Resources: Activity sheets

Instructions:

- Javeria and Tina drove to their aunt's house. Javeria drove $9\frac{3}{4}$ kilometers. Tina drove 3500 meters before they arrived. How many kilometers had they driven in all?
- Mira flew 1234 kilometers to Lahore to visit her uncle. After picking up Mira, her uncle drove 20 kilometers to his house from the airport. How many kilometers had Mira traveled in all?
- Nobody wanted to ride the 22 kilometers back to town after the family reunion. So relatives rode 10 kilometers to the nearest hotel. How many kilometers did the family ride in all?

4. Activity: Pair Work

Learning Outcome: Recognise units of temperature in Celsius and Fahrenheit.

Resources: Activity sheets

Instructions:

Give the activity sheets to the students and ask each pair to read the scale.

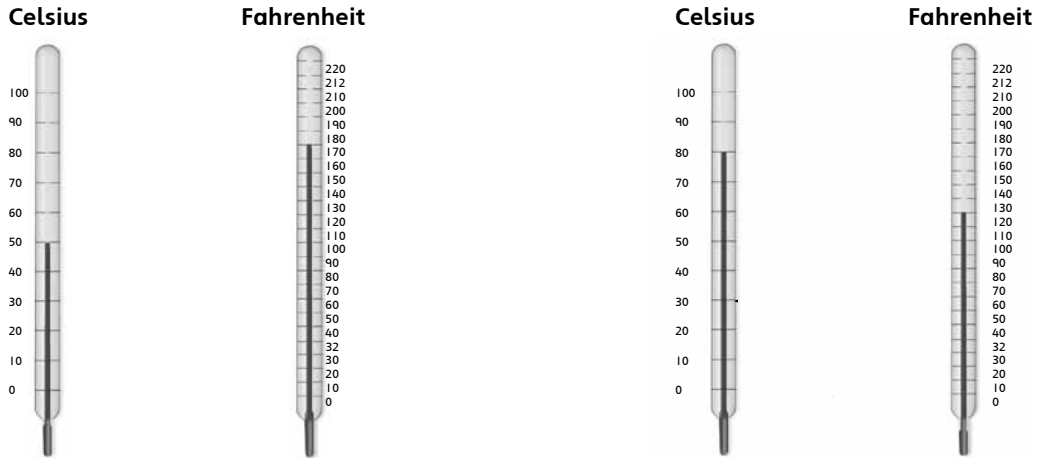

5. Activity: Pair Work

Learning Outcome: Solve real life problems involving conversion, addition and subtraction of units of temperature.

Resources: Activity sheets

Instructions:

Place	Country	Temperature
Karachi	Pakistan	32°C
Mumbai	India	29°C
Ottawa	Canada	26°C
Canberra	Australia	16°C
Miami	United States of America	31°C
London	United Kingdom	23°C

Put the temperatures in order from coldest to warmest. _____

How much colder is Canberra from London? _____

How much warmer is Karachi from Mumbai? _____

Quebec is 5°C colder than Ottawa today. What is the temperature in Quebec today?

What is the difference between the temperatures in the warmest and the coldest place?



Model Lesson Plan

Topic

Temperature

Duration

2 Periods

Specific Learning Objectives

By the end of the lesson students will be able to convert numbers given on the Celsius scale to the Fahrenheit scale.

Key Vocabulary

temperature, Celsius scale, Fahrenheit scale

Resources

Thermometer, Activity Worksheet

Strategy

Starter: Engagement Activity

Whole class discussion (5 mins)

Show a thermometer to the students and tell them that temperature is measured using a thermometer. It can be measured in two units Celsius and Fahrenheit.

Main Developmental Activity

Demonstration (10 mins)

A conversation with the students is useful to gauge their knowledge about temperature and the thermometer. This may be followed up with a little discussion on how a thermometer works and a practical demonstration with a real-life thermometer.

Tell the students that when we place a pan full to the rim with water on a fire, and the water heats, it bubbles over the rim and spills. The mercury thermometer also behaves similarly. When it is heated, it expands and spills into the bore.

The mercury in the thermometer contracts when there is a fall in temperature.

Explain how to convert the two units of temperature by using the following formulas:

$$^{\circ}\text{C} = ^{\circ}\text{F} - 32 \times \frac{5}{9}$$

$$^{\circ}\text{F} = ^{\circ}\text{C} \times \frac{9}{5} + 32$$

Addition work (optional)

The students can carry out a fun activity where they record the daily maximum temperature over a week.

- Record the temperature in Fahrenheit for each of the days.
- On which day of the week the temperature was maximum?
- On which day of the week the temperature was minimum?
- What is the different between the maximum and the minimum temperatures?

Pair Work (30 mins)

- Arrange four glasses of water at different temperatures as given in the activity worksheet. Help students to read the temperature of each glass using a thermometer and record their findings in the worksheet.

Activity Worksheet

Glass filled with	Temperature in °C	Convert °C to °F
Hot water		
Warm water		
Chilled water		
Ice cubes		

Written Assignments (30 mins)

Ex 5e Q4 (a to f)

Wrap up (5 mins)

Do you know which is the hottest and the coldest continent and why?



Suggested Time Frame

8-10 periods



Learning Curve

Students are familiar with the unitary method and know how to prepare bills. Here, they will learn to prepare bills of larger amounts using measurements of weight and capacity together in a bill. Students in their previous classes learnt about fractions. Now, in this unit they will define the ratio of two numbers which will lead them to define and identify direct and inverse proportion. They will be able to solve real-life problems involving direct and inverse proportions.



Real-life Application

The unitary method is important when it comes to cooking and baking as recipes require specific ratios of different ingredients. When we go shopping we buy things in bulk. Using the unitary method enables us to find the price of one unit or any quantity we require.



Frequently Made Mistakes

Students only tend to make mistakes when they are unable to understand the language of the word problems, leading them to performing incorrect operations.



Summary of Key Facts

- Ratio is the comparison of two quantities.
- Ratios can be written as a fraction or using a symbol.
- Ratios must be simplified to the lowest term.
- A ratio has no unit.
- Proportion is a statement, showing the relation of two equivalent ratios.

- There are two types of proportion: direct proportion and inverse proportion.
- When one quantity increases as the other increases or one quantity decreases as the other decreases, the quantities are said to be in direct proportion.
- When one quantity increases as the other decreases, or one quantity decreases and the other increases, they are set to be inversely proportion.



Suggested Activities

1. Activity: Group Activity

Learning Outcome: Calculate value of many objects of the same kind when the value of one of these objects is given.

Resources: Grocery item list

Instructions:

- Provide a list of 5 grocery items to each group of students. State the unit price of each item and ask the students to calculate the amount needed to buy these grocery items.
- Ask each student of the group to calculate the price of each item.

Grocery List	Price List
1 dozen eggs	cost of 1 egg Rs 8
2 dozen bananas	cost of 1 banana Rs 10
2 kg sugar	cost of 1 kg sugar Rs 80
5 liters of milk	cost of 1 litre of milk Rs 90
3 kgs of flour	cost of 1 kg of flour Rs 45

2. Activity: Pair Work

Learning Outcome: Calculate ratios of different quantities.

Resources: Recipe Cards

Instructions:

- Divide the class into pairs.
- Explain how to calculate ratios of different quantities.
- Each pair to be given a recipe card and a worksheet related to the recipe card.
- Responses are to be shared with the rest of the class.

RECIPE CARD

TOMATO SOUP

To make tomato soup for 4 people I need:

- 6 Tomatoes
- 1 Potato
- 1 Onion
- 1 Carrot
- 2 Table spoon of olive oil
- 2 Cups of vegetable stock
- 4 Pieces of bread

To make tomato soup for 8 people I need:

- _____ Tomatoes
- _____ Potato
- _____ Onion
- _____ Carrot
- _____ Table spoon of olive oil
- _____ Cups of vegetable stock
- _____ Pieces of bread

3. Activity: Individual Work

Learning Outcome: Express one quantity as a ratio of another quantity in their simplest form.

Instructions:

- Expose the students to the rules for expressing one quantity as a ratio of another in their simplest form.
- Give the following worksheet for students to work individually or in pairs.
- Take feedback of the strategies used to solve the worksheet.



1. What is the ratio of stars to squares? _____ : _____

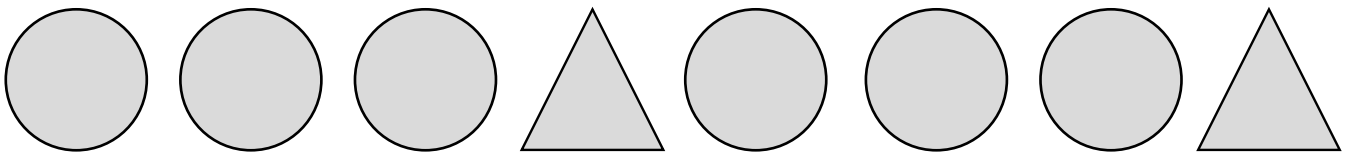

2. What is the ratio of circles to triangles? _____ : _____

3. What is the ratio of circles to triangles when simplified? _____ : _____

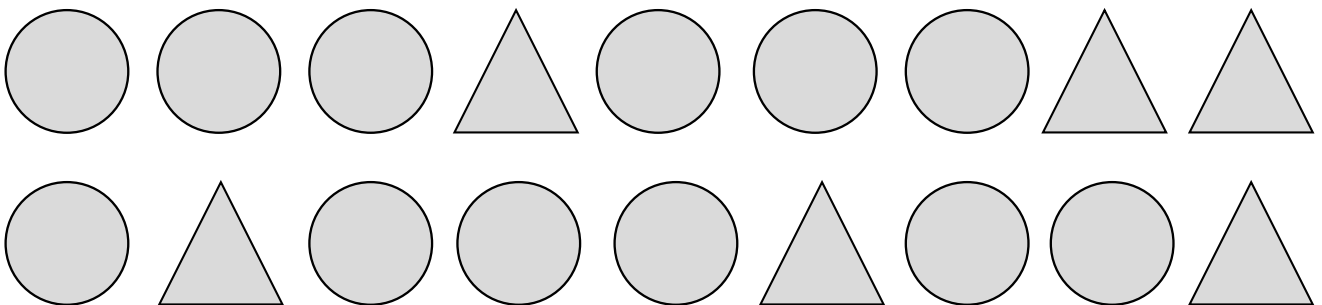

4. What is the ratio of triangles to circles? _____ : _____
5. What is the ratio of triangles to circles when simplified? _____ : _____
6. What is the ratio of circles to triangles when simplified? _____ : _____

4. Activity: Individual Work

Learning Outcome: Find the unit rate.

Resources: Activity sheet

Instructions:

- Give each student an activity sheet to work individually.

40 copies in 8 minutes = $40 : 8 =$  copies per minute

30 pints of juice in 5 containers = _____ : _____ =  pints per container

5 tanks with 265 fish = _____ : _____ =  fish per tank

4 trays with 48 ice cubes = _____ : _____ =  ice cubes per tray

4 boxes can hold 40 books = _____ : _____ =  books per box

5 game controllers had 25 buttons = _____ : _____ =  buttons per



Model Lesson Plan

Topic

The Unitary Method

Duration

2 Periods

Specific Learning Objectives

By the end of the lesson students will be able to apply the unitary method involving real-life problems.

Key Vocabulary

unitary method, bills

Resources

Empty boxes, Price lists

Worksheet

Classroom shop; shopping lists in the following format:

Popcorn: Rs 10 per pack

Flour: Rs 52 per kg

Butter: Rs 250 per kg

Orange juice: Rs 69 per bottle

Strategy

Starter: Engagement Activity

Role play (15 mins)

Set up a small market in the classroom and assign students different roles such as shopkeeper and customer (tell students before conducting the lesson to bring empty boxes of the above mentioned items or any other, so that they can easily set up the market).

Main Developmental Activity

Group Work (20 mins)

The class will be divided into groups. One group will be playing the role of the shop keepers, others will be buyers. Students prepare the bill based on the shopping lists for a number of problems given to them.

Example:

For a birthday party, Sana bought 20 packets of popcorn, 2.5 kg flour, 1.25 kg butter, and 5.25 litre of orange juice.

Prepare a bill for her using the cost of each item given on the worksheet.

Quantity	Description	Cost per unit	Total cost
20 packets	popcorn	Rs 10	Rs 200
2.5 kg	flour		
1.25 kg	butter		
5.25 litre	orange juice		

Feedback (10 mins)

Ask students about the total bill. How did they calculate it?

Written Assignments (30 mins)

Ex 6a Q4 and word problems 1 to 4.

Wrap up (5 mins)

A short discussion should be held on the importance of the unitary method. Ask students where they use the unitary method in their daily life.

7

Geometry



Suggested Time Frame

8-10 periods



Learning Curve

Students have learnt to draw vertical and horizontal lines, they also know that angles are measured and named according to their sizes (acute, right, obtuse, straight, and reflex angles) with a protractor and according to their positions (adjacent, complementary, and supplementary). In this unit, students will identify different triangles according to their sides and angles, and the hypotenuse of a right-angled triangle. Students will also identify and name different types of quadrilaterals. They will now use compasses and rulers to construct triangles.



Real-life Application

Geometry helps:

- in the field of medicine e.g. X-ray and ultrasound.
- in the accurate calculation of physical distances.
- in the field of astronomy to map the distance between planets and stars.
- in computer aided designs, it entails lines, curves, and angles.
- in designing buildings, bridges, and furniture, patterns, and geometrical designs.



Frequently Made Mistakes

Students enjoy the topic of geometry at this level and make very few mistakes. They only sometimes are unable to identify or name angles and triangles according to their sides or angles.



Summary of Key Facts

- An acute angle is less than 90° , a right angle is equal to 90° , an obtuse angle is more than 90° but less than 180° and a reflex angle is more than 180° .
- Adjacent angles have a common vertex.
- Two angles are complementary if their sum is 90° .
- Two angles are supplementary if their sum is 180° .
- The sides of an equilateral triangle are equal in length and each angle is of 60° .
- An isosceles triangle has two equal sides and two equal base angles.
- All three sides of a scalene triangle have different lengths, therefore, all three angles are different.
- The sum of all angles in a triangle is equal to 180° .
- In a right-angled triangle, one of the angles is 90° .
- In an acute-angled triangle, all the angles are acute.
- In an obtuse-angled triangle, one angle is obtuse and the other two angles are acute.



Suggested Activities

1. Activity: Individual Work

Learning Outcome: Identify different types of angles.

Instructions:

Ask students to bring pictures of different items or objects (easily available at home), on which they can identify and make angles. For example, a fork in a glass or a table and chair, clock, flag, or any geometrical shape. Ask them to identify the type of angle. (This task can be given to students as homework also). They may bring a picture of a clock with angles marked as shown.

Ask the students to share their findings with the rest of the class and display their work in the class.

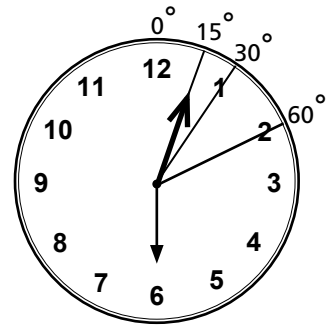

2. Activity: Individual Work

Learning Outcome: Identify different types of triangles.

Resources: Worksheet on triangles.

Instructions:

- Divide the class into groups.
- Provide each group with a worksheet of different types of triangles.
- Ask students to identify the type of each triangle then name it and give a reason for it.

Worksheet:

Identify the following types of triangles and explain.

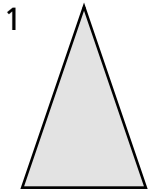

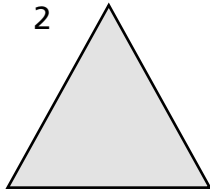

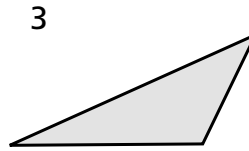

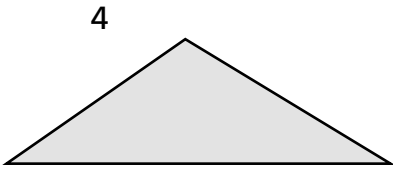

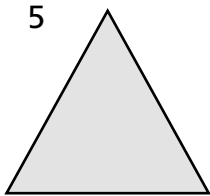

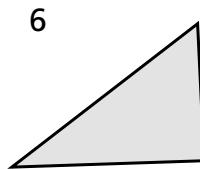

3. Activity: Individual Work

Learning Outcome: Identify different types of quadrilaterals.

Resources: Activity Sheets

Instructions

- Explain the properties of different quadrilaterals used to identify them.



_____ Reason: _____



_____ Reason: _____

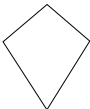

_____ Reason: _____



_____ Reason: _____

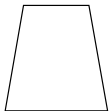

_____ Reason: _____

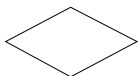

_____ Reason: _____



Model Lesson Plan

Topic

Angles

Duration

2 periods

Specific Learning Objectives

By the end of the lesson students will be able to define and measure reflex angles.

Key Vocabulary

acute angle, right angle, obtuse angle, reflex angle

Resources

A large size wooden geometry box

Strategy

Starter: Engagement Activity (5 mins)

Show the big wooden geometry box to the class and ask them to guess the topic. Once the students have guessed the topic then ask them to define an acute angle, right angle, and obtuse angle and side-by-side draw these angles on the board using the wooden protractor.

Main Developmental Activity

Demonstration (15 mins)

Start with a quick run through of the work done in the previous class, before moving on to measuring and constructing angles using a protractor. Working on the blackboard with a large wooden protractor is useful.

Students know that:

- when a line XY turns a full circle at point X (below) before returning to its original position, the measure of degrees at the point of turning is 360° .

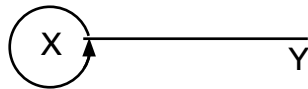

- a reflex angle is greater than 180° . Reflex angles can be drawn in two ways.

Look at the following figures:

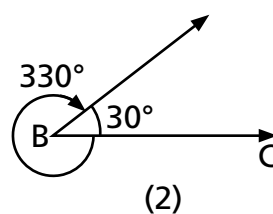
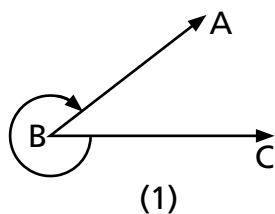

Use a protractor to draw an acute angle. Let angle $ABC = 30^\circ$

Subtract: $360^\circ - 30^\circ = 330^\circ$

The outer angle $ABC = 330^\circ$ which is the required reflex angle.

Group Work (15 mins)

Working in groups is fun. Divide the class into groups.

Instructions:

Ask group one to construct an acute angle on A4 size sheet (any size to be given) then calculate and measure its corresponding reflex angle. In the same manner, the rest of the groups will construct a right angle, obtuse angle and their corresponding reflex angles.

Ask each group which angle they have drawn and what is its corresponding reflex angle.

Written Assignment (40 mins)

Ex 7a Q7 (a, b, c, d), Q8 (a, b, c, d).

Wrap up (5 mins)

Hold a small discussion on the importance and application of different angles in our daily life.

8

Perimeter and Area



Suggested Time Frame

8-10 periods



Learning Curve

In Grade 3, students have calculated the perimeter of a square and a rectangle and in Grade 4 they calculated areas and perimeters of simple shapes. In this unit, students will move on to calculate areas of composite shapes using formulas.



Real-life Application

The calculation of area is beneficial when we want to find:

- how many tiles are needed to cover the floor, or the size of carpet required for a room.
- the covered area of a plot for construction of a building.



Frequently Made Mistakes

Students often get confused between area and perimeter, as they do not realise that area is the inside part and perimeter is the sum of the sides of the outer boundary. They also make mistakes in writing the correct units of area and perimeter.



Summary of Key Facts

- Perimeter is the sum of all the sides of the outer boundaries of a closed region.
- Area is a surface covered by a closed region.
- Composite shapes consist of two or more shapes.



Suggested Activities

1. Activity: Group Work

Learning Outcome: Find the perimeter of the given region.

Resources: Activity Worksheet

Instructions:

- Divide the class into groups.
- Provide each group with a worksheet as shown in the sample.
- Ask the students to solve the worksheet and exchange it with the other group for peer checking.

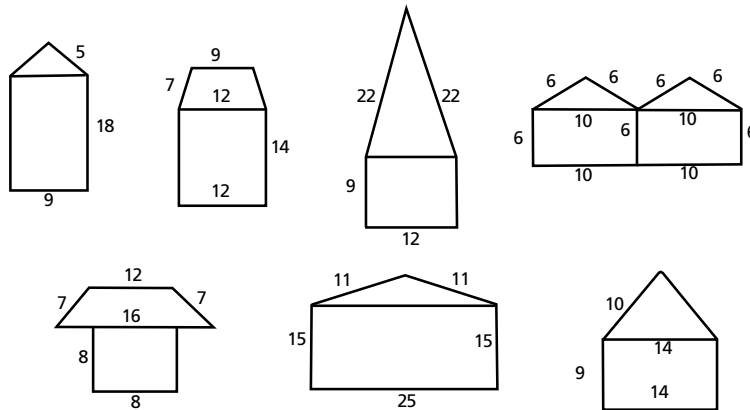

2. Activity: Pair Work

Learning Outcome: Find the area and perimeter of the given simple shapes.

Resources: Activity Worksheet

Instructions:

- Divide the class into pairs.
- Time the students and give a reward to the winning pair.

1. What is the height and width of each side?

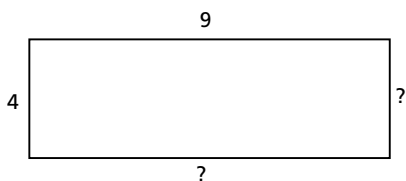

2. What is the perimeter?



3. What is the area?

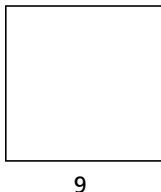

4. What is the area?

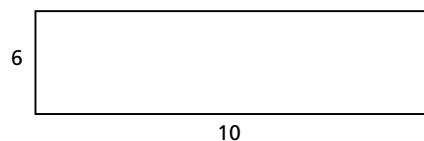

3. Activity: Individual Activity

Learning Outcome: Find the area of squares and quadrilaterals.

Resources: Square grid sheet (each small box on the grid is equal to 1 square unit).

Instructions:

- Give a square grid sheet to each student and tell them to work on it.
- Draw a quadrilateral that has an area of 20 square units
- Draw two squares and label them, A and B. Square A has an area of 4 square units. Square B has an area 9 times greater than square A.



Model Lesson Plan

Topic

Area and perimeter of composite shapes.

Duration

2 periods

Specific Learning Objectives

By the end of the lesson students will be able to calculate area and perimeter of composite shapes.

Key Vocabulary

area, perimeter, simple shapes, composite shapes

Resources

Chart papers, markers, cut-outs of different composite shapes.

Strategy

Starter: Engagement Activity

Recall (5 mins)

Paste cut-outs of simple 2D shapes like square and rectangle on the board as shown in Fig. 1 ask the students if they can find the area and perimeter of these shapes. Once they say yes, join the shapes as shown Fig. 2 and ask how can the area and the perimeter of the new composite shape be found using the formula for the area and perimeter of a square and rectangle?



Fig. 1

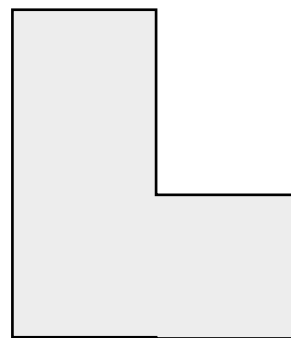

Fig. 2

Square

Area of a square = length \times length = (length)²

Perimeter = 4 (length)

Rectangle

Area of a rectangle = length \times breadth

Perimeter = 2 (length + breadth)

Main Developmental Activity

Setting: Divide the class into groups. Each group will consist of 4 members.

Group Work (20 mins)

- Divide the class into groups.
- Provide each group with the different composite shapes and ask them to calculate the area and perimeter of the given shape on a chart paper.

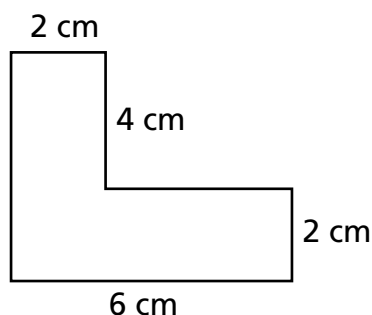

Feedback (15 mins)

Ask each group to represent their work and tell the other groups to give remarks on each other's work.

Written Assignments (30 mins)

Ex 8a Q3, 4, 7.

Wrap up (5 mins)

Ask students where they see composite shapes in their surroundings.





Suggested Time Frame

4-6 periods



Learning Curve

Students will work on their previous knowledge of how to read and interpret block graphs and line graphs. They will draw block graphs and column graphs in horizontal and vertical form. Furthermore, they will also learn to calculate the average of given data.



Real-life Application

- Data is useful for a census which gives the government facts and figures about the population.
- Bar graphs tells you about the preferences of different groups of people.
- Averages can be used to calculate the average rainfall in a particular region or the rate of a batsman in a cricket match (which tells us about his performance) Averages help people predict the annual, semi or quarterly performance of a company.



Frequently Made Mistakes

- Students often make mistakes when drawing bar graphs, where they don't leave a gap between the two bars (there should be a gap between the two bars).



Summary of Key Facts

- To find the average of a set of quantities, add them together, then divide the total by the number of quantities.
- Block graphs are used to represent data. Types of items are indicated on the horizontal axis and the number of items are presented on the vertical axis.
- A bar graph is a representation of data which helps us compare information.
- A collection of facts and statistics gathered or available for analysis and calculation about a specific topic is called data.



Suggested Activities

1. Activity: Group Work

Learning Outcome: Collect data, draw, and interpret the data in the form of bar graph.

Resources: Chart Paper, Markers, Paper Plates

Instructions:

- Talk to your students about the importance of having breakfast in the morning. Discuss healthy options for breakfast.
- Give one paper plate to each student.
- Ask students to write down what they had for breakfast that morning, and to draw an image of it.
- Students who did not have breakfast should just write 'nothing'.
- Group the breakfast items into categories such as 'milk and cereal', 'fruits', 'toast', 'eggs', etc.
- Explain that a bar graph will make it easy to organise the students' responses.
- Each group will sort out and organise the data by gathering all plates which represents the same category of breakfast, for example, milk and cereals at one table.
- Spread the chart paper on the board.
- Call out each group one by one. They will tell the data of the particular category which they had on their table.
- Construct a bar for the particular breakfast category on the chart paper.
- Repeat the same steps for each of the remaining categories. Analyse the bar graph and discuss the data.

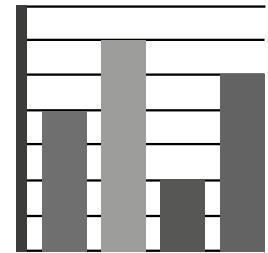

Bar Graph

2. Activity: Pair Work

Learning Outcome: Find the mean of the given data.

Resources: Deck of cards, Paper, Pencil

Instructions:

- Divide the class into pairs.
- Take out any 10 cards randomly out of the deck.
- Provide each pair with the cards.
- Instruct students to find the total value of the numbers on the cards and divide it by the total cards.
- One student will arrange the cards and the other will add all the numbers of the cards.
- Take feedback from each pair, ask them how they calculated the mean.



Model Lesson Plan

Topic

Averages

Duration

2 Periods

Specific Learning Objectives

By the end of the lesson students will be able to calculate the average of a set of quantities.

Key Vocabulary

averages, total, sum

Resources

White board, Markers

Strategy

Starter: Engagement Activity (5 mins)

Start your lesson by asking any ten students about their age and jot down on the board in the following manner.

10, 8, 9, 9, 8, 10, 9, 10, 8, 9

Just collect the data and move to the explanation.

Main Developmental Activity

Teacher's Exposition (10 mins)

To find the average of a set of quantities, add them and then divide the total by the number of quantities. You have taken the data of 10 students, now find the sum of their ages and divide by the number of students (10).

$$\frac{10 + 8 + 9 + 9 + 8 + 10 + 9 + 10 + 8 + 9}{10} = \frac{90}{10} = 9$$

This means that there may be some students around 10 years of age and some may be of 8 years of age, but the average tells us that the maximum number of students are 9 years old.

Group Work (20 mins)

Instructions:

- Divide the class into groups.
- Ask students to use white boards and markers.
- Give each group different data to calculate average.

For Example:

Group 1

If there are 20 students in the class, the number of students who wore wrong uniform on each day of the week is as follows:

Monday 7 students, Tuesday 13 students, Wednesday, 14 students, Thursday 10 students, and Friday 6 students. Find the average number of students who wore the wrong uniform during the week.

Ask each group to share their work with the class, by showing their working on the white boards.

Written Assignments (40 mins)

Ex 9a Q1, 2, 3, 4

Wrap up (5 mins)

Discuss the importance of averages in daily life.



Assessment

A teacher's journey involves three stages Exposition, Practice, and Consolidation.

Exposition is the setting forth of content, and the quality and extent of the information relayed.

Practice involves problem solving, reasoning and proof, communication, representations, and correction.

Assessment is the final stage of consolidation of the process of learning. Assessment of teaching means taking a measure of its effectiveness.

Formative assessment is measurement for the purpose of improving it.

Summative assessment is what we normally call evaluation.

An ideal and fair evaluation involves a plan that is comprehensive. It covers a broad spectrum of all aspects of mathematics. The assessment papers should test all aspects of topics taught. These can be demarcated into categories: basic, intermediate, and advanced content.

The advanced content should be minimal as it tests the most able students only.

Multiple choice questions, also known as fixed choice or selected response items, require students to identify the correct answer from a given set of possible options.

Structured questions assess various aspects of students' understanding: knowledge of content and vocabulary, reasoning skills, and mathematical proofs.

All in all, the teaching's assessment of students' ability must be based on classroom activity, informal assessment, and final evaluation at the end of the topic and/or the year.

Specimen Paper 1

Grade V

MATHEMATICS

Instructions:

- Select the correct answer from the given options.
- Shade the circle with the correct answer using blue or black pen only. ●
- No marks will be given if more than one circle is shaded.

Section – A

Total Marks: 30

Q. 1	<p>A ten digit number in the International System is expressed as</p> <ul style="list-style-type: none"> <input type="radio"/> hundred million <input type="radio"/> thousand million <input type="radio"/> one billion <input type="radio"/> ten billion 	Q. 5	<p>$3\ 590\ 125 - 3\ 270\ 125$</p> <ul style="list-style-type: none"> <input type="radio"/> 786 250 <input type="radio"/> 152 500 <input type="radio"/> 320 125 <input type="radio"/> 3 20 000
Q. 2	<p>The place value of 7 in 24 278 591 in the International System is</p> <ul style="list-style-type: none"> <input type="radio"/> 7 hundred thousand <input type="radio"/> 70 thousand <input type="radio"/> 7 lac <input type="radio"/> 70 lac 	Q. 6	<p>$52\ 860 \times \square = 5\ 286\ 000$</p> <ul style="list-style-type: none"> <input type="radio"/> 10 <input type="radio"/> 100 <input type="radio"/> 1000 <input type="radio"/> 110
Q. 3	<p>$400\ 000 + 7\ 400\ 000$</p> <ul style="list-style-type: none"> <input type="radio"/> 740 000 <input type="radio"/> 7 800 000 <input type="radio"/> 11 400 000 <input type="radio"/> 7 440 000 	Q. 7	<p>1, 4, 8, and 16 are factor of</p> <ul style="list-style-type: none"> <input type="radio"/> 8 <input type="radio"/> 4 <input type="radio"/> 16 <input type="radio"/> 2
Q. 4	<p>$2525 \div$ divided by 505 is</p> <ul style="list-style-type: none"> <input type="radio"/> 5 <input type="radio"/> 15 <input type="radio"/> 10 <input type="radio"/> 3 	Q. 8	<p>$\frac{4}{5}, \frac{6}{5}, \frac{13}{5}$ are all</p> <ul style="list-style-type: none"> <input type="radio"/> like fractions <input type="radio"/> mixed fractions <input type="radio"/> proper fractions <input type="radio"/> unlike fractions

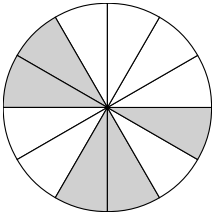
Q. 9	<p>The fraction represented by the shaded part is</p> <ul style="list-style-type: none"> <input type="radio"/> $\frac{12}{5}$ <input type="radio"/> $\frac{3}{12}$ <input type="radio"/> $\frac{5}{12}$ <input type="radio"/> $\frac{12}{3}$ 	Q. 14	<p>0.6 expressed as a common fraction is</p> <ul style="list-style-type: none"> <input type="radio"/> $\frac{3}{5}$ <input type="radio"/> $\frac{3}{50}$ <input type="radio"/> $\frac{3}{100}$ <input type="radio"/> 0.6
Q. 10	<p>$\frac{12}{5} \div \frac{12}{5} =$</p> <ul style="list-style-type: none"> <input type="radio"/> 9 <input type="radio"/> 1 <input type="radio"/> 5 <input type="radio"/> $\frac{255}{25}$ 	Q. 15	<p>$12.05 \times 1000 =$</p> <ul style="list-style-type: none"> <input type="radio"/> 1205.000 <input type="radio"/> 12.05000 <input type="radio"/> 1205000 <input type="radio"/> 12050
Q. 11	<p>$10 \times \frac{3}{5}$</p> <ul style="list-style-type: none"> <input type="radio"/> 6 <input type="radio"/> 60 <input type="radio"/> $\frac{53}{5}$ <input type="radio"/> 150 	Q. 16	<p>Round off 15.6938 to 2 decimal places</p> <ul style="list-style-type: none"> <input type="radio"/> 15.69 <input type="radio"/> 15.60 <input type="radio"/> 15.70 <input type="radio"/> 156.93
Q. 12	<p>The sum of $\frac{1}{7}$ and $\frac{6}{7}$ is</p> <ul style="list-style-type: none"> <input type="radio"/> 7 <input type="radio"/> $\frac{6}{49}$ <input type="radio"/> 1 <input type="radio"/> $\frac{16}{7}$ 	Q. 17	<p>Express 36% as a decimal fraction.</p> <ul style="list-style-type: none"> <input type="radio"/> 3.6 <input type="radio"/> 0.36 <input type="radio"/> 360.0 <input type="radio"/> 300.6
Q. 13	<p>$\frac{6}{20}$ as a decimal fraction is</p> <ul style="list-style-type: none"> <input type="radio"/> 0.2 <input type="radio"/> 0.3 <input type="radio"/> 0.6 <input type="radio"/> 0.5 	Q. 18	<p>The average of 10, 20, 30, 40 and 50 is</p> <ul style="list-style-type: none"> <input type="radio"/> 40 <input type="radio"/> 25 <input type="radio"/> 30 <input type="radio"/> 3

Q. 19	A reflex angle is <input type="radio"/> less than 180° <input type="radio"/> greater than 180° <input type="radio"/> equal to 0° <input type="radio"/> equal to 90°	Q. 25	Convert 412 m into cm. <input type="radio"/> 4120 cm <input type="radio"/> 41200 cm <input type="radio"/> 41.2 cm <input type="radio"/> 4.12 cm
Q. 20	The sum of the lengths of all the sides of a rectangle is called the <input type="radio"/> area <input type="radio"/> perimeter <input type="radio"/> average length <input type="radio"/> sum of angles	Q. 26	$5 : 10 : 15$ in its simplest form is <input type="radio"/> $5 : 2 : 3$ <input type="radio"/> $1 : 2 : 3$ <input type="radio"/> $3 : 2 : 1$ <input type="radio"/> $25 : 50 : 75$
Q. 21	Amount is equal to <input type="radio"/> Interest – Principal <input type="radio"/> Principal + Interest <input type="radio"/> Principal – Interest <input type="radio"/> Double of Principal	Q. 27	In 12 weeks there are <input type="radio"/> 84 days <input type="radio"/> 7 days <input type="radio"/> 14 days <input type="radio"/> 365 days
Q. 22	9, 18 and 27 are multiples of <input type="radio"/> 3 only <input type="radio"/> 9 only <input type="radio"/> 3 and 9 <input type="radio"/> 6	Q. 28	In 4 years there are <input type="radio"/> 16 months <input type="radio"/> 8 months <input type="radio"/> 48 months <input type="radio"/> 36 months
Q. 23	Express 45% as a common fraction. <input type="radio"/> $\frac{5}{2}$ <input type="radio"/> $\frac{9}{2}$ <input type="radio"/> $\frac{9}{20}$ <input type="radio"/> $4\frac{5}{100}$	Q. 29	Express 4 km + 540 m in metres <input type="radio"/> 40540 m <input type="radio"/> 4540 m <input type="radio"/> 544 m <input type="radio"/> 940 m
Q. 24	Convert 105 km into metres. <input type="radio"/> 1500 m <input type="radio"/> 10.5 m <input type="radio"/> 1050 m <input type="radio"/> 105000 m	Q. 30	How many wheels are there on 4 bicycles? <input type="radio"/> 4 <input type="radio"/> 16 <input type="radio"/> 8 <input type="radio"/> 2

Solve all the questions.

Section – B

Total Marks: 45

Q. 1 Simplify:

$$5 + [35 - \{18 + (7 \times 2)\}]$$

4 marks

Q. 2 i) Find the LCM of 6, 18, 24

3 marks

ii) Find the HCF of 7, 21, 35

3 marks

Q. 3 Simplify:

$$3\frac{1}{5} + 2\frac{1}{15} - \frac{1}{10}$$

4 marks

Q. 4 Simplify:

$$15.64 \times 0.5 + 100.6$$

5 marks

Q. 5 The cost of a 1 kg rice bag is Rs 150.75. What will be the cost of 8 kg of rice?

5 marks

Q. 6 If 5 cartons of milk weigh 12.5 kg, what will be the weight of one carton?

5 marks

Q. 7 Convert:

i) 12 hours and 50 minutes into minutes

2 marks

ii) 104°F into $^{\circ}\text{C}$

3 marks

Q. 8 Construct a triangle ABC where $m\overline{AB} = 4\text{ cm}$,

5 marks

$m\angle B = 90^{\circ}$ $m\angle A = 45^{\circ}$ Also find $m\overline{AC}$.

Q. 9 Find the area of a rectangle whose length is 7 cm and breadth in 5 cm.

2 marks

Q. 10 Study the graph given below and answer the questions.

4 marks

i) Which fruit is liked most?

ii) How many students like pears and melon? _____

iii) Which fruit is liked by the least number of students? _____

iv) What is the total number of students? _____

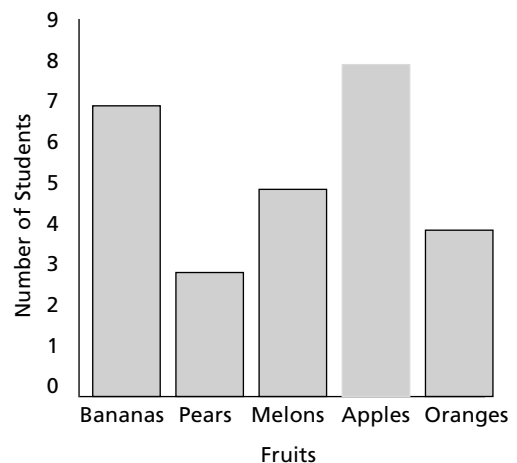

Specimen Paper 2

Grade V

MATHEMATICS

Instructions:

- Select the correct answer from the given options.
- Shade the circle with the correct answer using blue or black pen only. ●
- No marks will be given if more than one circle is shaded.

Section – A

Total Marks: 30

<p>Q. 1</p>	<p>729 856 – 729 746</p> <p>○ 729 710</p> <p>○ 110</p> <p>○ 710 290</p> <p>○ 1 459 602</p>	<p>Q. 4</p>	<p>Express 309 km in metres.</p> <p>○ 39000 m</p> <p>○ 30900 m</p> <p>○ 309000 m</p> <p>○ 3.090 m</p>
<p>Q. 2</p>	<p>$\frac{3}{4} \times (\frac{5}{6} + \frac{9}{12}) = (\frac{3}{4} \times \square)$</p> <p>$+ (\frac{3}{4} \times \frac{9}{12})$</p> <p>○ $\frac{5}{6}$</p> <p>○ $\frac{15}{24}$</p> <p>○ $\frac{27}{45}$</p> <p>○ $\frac{12}{16}$</p>	<p>Q. 5</p>	<p>Which of the following fractions is equal to $\frac{3}{5}$?</p> <p>○ $\frac{6}{5}$</p> <p>○ $\frac{3}{10}$</p> <p>○ $\frac{9}{15}$</p> <p>○ $\frac{3}{25}$</p>
<p>Q. 3</p>	<p>Which of the following fractions is $\frac{1}{2}$ of $\frac{3}{8}$?</p> <p>○ $\frac{1}{8}$</p> <p>○ 4</p> <p>○ $\frac{3}{4}$</p> <p>○ $\frac{3}{16}$</p>	<p>Q. 6</p>	<p>Which fraction is equal to 0.38?</p> <p>○ $\frac{19}{50}$</p> <p>○ $\frac{19}{100}$</p> <p>○ $\frac{38}{1000}$</p> <p>○ $\frac{19}{300}$</p>

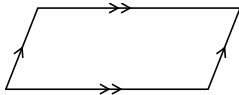
Q. 7	<p>How many days in 12 weeks?</p> <p><input type="radio"/> 48</p> <p><input type="radio"/> 84</p> <p><input type="radio"/> 60</p> <p><input type="radio"/> 72</p>	Q. 12	<p>The formula for area of a rectangle is</p> <p><input type="radio"/> $l \times b$</p> <p><input type="radio"/> $l \times l + b \times b$</p> <p><input type="radio"/> $2 \times b \times l$</p> <p><input type="radio"/> $\frac{2}{l \times b}$</p>
Q. 8	<p>Angle A in the given figure is equal to</p> <p><input type="radio"/> 45°</p> <p><input type="radio"/> 30°</p> <p><input type="radio"/> 90°</p> <p><input type="radio"/> 60°</p>	Q. 13	<p>One hundred thousand in figures is</p> <p><input type="radio"/> 10 00 000</p> <p><input type="radio"/> 100 000</p> <p><input type="radio"/> 10 000</p> <p><input type="radio"/> 1 001 000</p>
Q. 9	<p>An angle of 250° is called a</p> <p><input type="radio"/> reflex angle</p> <p><input type="radio"/> right angle</p> <p><input type="radio"/> acute angle</p> <p><input type="radio"/> obtuse angle</p>	Q. 14	<p>The sum of 8.9 and 9.8 is</p> <p><input type="radio"/> 1.87</p> <p><input type="radio"/> 187</p> <p><input type="radio"/> 18.7</p> <p><input type="radio"/> 17.17</p>
Q. 10	<p>The given figure is a</p>  <p><input type="radio"/> rectangle</p> <p><input type="radio"/> trapezium</p> <p><input type="radio"/> parallelogram</p> <p><input type="radio"/> square</p>	Q. 15	<p>The average of 2, 3, 4, and 7 is</p> <p><input type="radio"/> 7</p> <p><input type="radio"/> 4</p> <p><input type="radio"/> 16</p> <p><input type="radio"/> 64</p>
Q. 11	<p>Convert 3.64 m into cm.</p> <p><input type="radio"/> 364 cm</p> <p><input type="radio"/> 36.4 cm</p> <p><input type="radio"/> 36,400 cm</p> <p><input type="radio"/> 3640 cm</p>	Q. 16	<p>The difference of $\frac{15}{19}$ and $\frac{2}{38}$ is</p> <p><input type="radio"/> $\frac{3}{38}$</p> <p><input type="radio"/> $\frac{7}{38}$</p> <p><input type="radio"/> $\frac{14}{19}$</p> <p><input type="radio"/> $\frac{13}{19}$</p>

Q. 17	<p>There are 20 balloons in a bag. How many balloons are there in one dozen bags?</p> <p> <input type="radio"/> 240 <input type="radio"/> 32 <input type="radio"/> 20 <input type="radio"/> 24 </p>	Q. 22	<p>What is the lowest common multiple of 9 and 15?</p> <p> <input type="radio"/> 45 <input type="radio"/> 30 <input type="radio"/> 15 <input type="radio"/> 90 </p>
Q. 18	<p>$\frac{7}{16} \div \frac{21}{16}$</p> <p> <input type="radio"/> $\frac{147}{256}$ <input type="radio"/> 3 <input type="radio"/> $\frac{1}{3}$ <input type="radio"/> $\frac{1}{4}$ </p>	Q. 23	<p>$\frac{5}{8} \times \frac{2}{15}$</p> <p> <input type="radio"/> $\frac{75}{16}$ <input type="radio"/> $\frac{10}{12}$ <input type="radio"/> $\frac{7}{23}$ <input type="radio"/> $\frac{1}{12}$ </p>
Q. 19	<p>The place value of 7 in 9 784 560 is</p> <p> <input type="radio"/> 7 hundred <input type="radio"/> 7 thousand <input type="radio"/> 70 thousand <input type="radio"/> 7 hundred thousand </p>	Q. 24	<p>Convert 5 hours 40 minutes into minutes.</p> <p> <input type="radio"/> 200 <input type="radio"/> 3400 <input type="radio"/> 540 <input type="radio"/> 340 </p>
Q. 20	<p>$9.06 + 0.06$</p> <p> <input type="radio"/> 91.6 <input type="radio"/> 9.12 <input type="radio"/> 912 <input type="radio"/> 90.06 </p>	Q. 25	<p>The length of a rectangle is 3 times its breadth. If breadth is 3 cm, then its length is</p> <p> <input type="radio"/> 4 cm <input type="radio"/> 9 cm <input type="radio"/> 27 cm <input type="radio"/> 6 cm </p>
Q. 21	<p>25 °C converted to °F is</p> <p> <input type="radio"/> 57 °F <input type="radio"/> 13 °F <input type="radio"/> 7 °F <input type="radio"/> 77 °F </p>		

Q. 26

In the following bar graph identify the month which has the least number of rainy days.

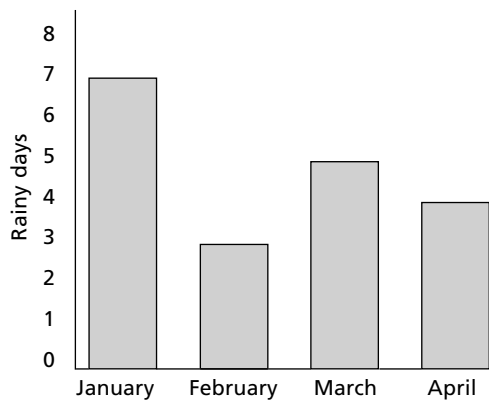

-

Q. 28

52 059 307 in words is

- Fifty two million
- Fifty two million, fifty nine thousand three hundred and seven
- Five million two hundred and fifty nine thousand three hundred and seven
- Fifty two lac fifty nine thousand three hundred and seven

Q. 27

The ratio of two numbers is 3:2. If the first number is 24, then what will be the other number?

- 16
- 8
- 4
- 48

Q. 29

Eight million nine thousand and seventy written in numbers.

- 8 09 070
- 800 970
- 8 009 070
- 8 000 970

Q. 30

Which of the following is an equilateral triangle?

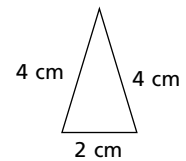
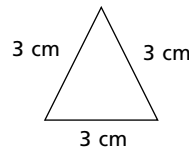
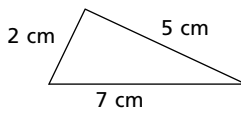
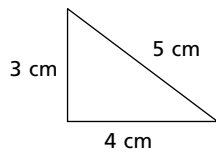

Q. 1 Simplify:

$$[30 \times \{15 + (3.6 + 1.2)\}] + 55$$

4 marks

Q. 2 A fruit seller sells 345 apples packed in 15 boxes.
How many apples are there in one box?

3 marks

Q. 3 There are 120 marbles in a bag. How many marbles will be in 87 such bags?

3 marks

Q. 4 Find the area of the given shape.

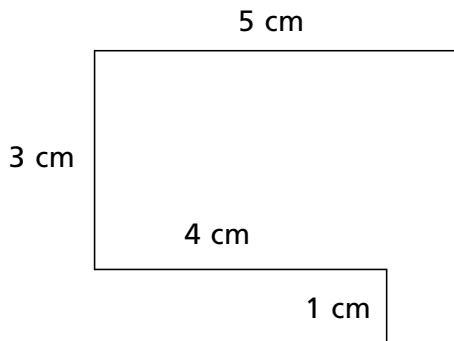

4 marks

Q. 5 i) Find the LCM of 12, 16, 20.

3 marks

ii) Find the HCF of 30 and 225.

3 marks

Q. 6 Simplify:

i) $12\frac{2}{3} \times 5\frac{1}{4}$

3 marks

ii) $\frac{46}{3} \div \frac{23}{9}$

3 marks

Q. 7 Construct a triangle PQR where $m\overline{PQ} = 4$ cm
 $m\overline{PR} = 6$ cm and $\angle QPR = 40^\circ$.

5 marks

Q. 8 Rashid's monthly expenditures from January to June are Rs 2000, Rs 3500, Rs 2600, Rs 2010, Rs 1990, and Rs 2150 respectively.
Calculate his average expenditure.

4 marks

Q. 9 i) Asif saved Rs 496.80. His uncle gave him Rs 215.50. How much money does he have altogether?

3 marks

ii) Raza spent Rs 95.15 in shopping. He had Rs 155 in his wallet.
How much money was left with him?

3 marks

Q. 10 The graph given below shows the number of cars sold in a month at a car showroom. 4 marks

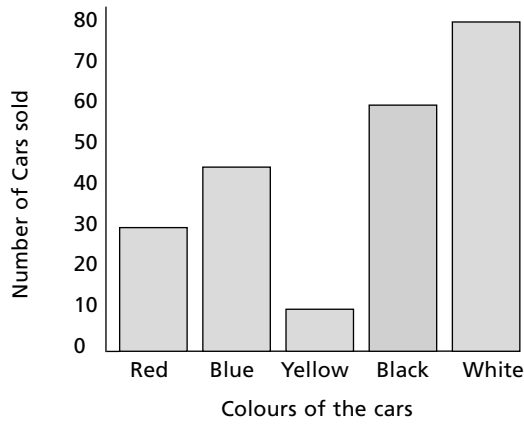

Answer the questions.

- i) How many blue cars were sold? _____
- ii) Which is the most popular colour? _____
- iii) Which is the least popular colour? _____
- iv) What is the total number of cars sold? _____